

TTP 4-A

NARROW DIRECTIVITY TWO-WAY SPEAKER

DESCRIPTION

The TTP 4-A point source speaker module delivers top-quality sound for highly demanding events indoors or outdoors on small to medium-sized areas. Its design provides the audio engineer with the best tonal balance and intelligibility with an unobtrusive and adaptable footprint. It is the preferred sound set-up for stacked and flown systems when a controlled dispersion is required. With all the advantages of TT+ technology, such as coherent directivity, power, and precision, it's designed for professional applications.



FEATURES

- 135 dB max SPL
- 60° x 25° coverage
- LF 2 x 10" neodymium woofer, 3.0" voice coil
- HF 1.5" Nd comp. driver 4.0" voice coil
- 2 x Class-D amplifiers, 1600 Watt RMS total power
- 45 - 20.000 Hz frequency range
- RDNet on board
- FiRPHASE 0° linear phase

TECHNICAL SPECIFICATIONS

Acoustical specifications	Frequency Response:	45 Hz ÷ 20000 Hz
	Max SPL @ 1m:	135 dB
	Horizontal coverage angle:	60°
	Vertical coverage angle:	25°
Transducers	Compression Driver:	1 x 1.5" neo, 4.0" v.c
	Woofers:	2 x 10" neo, 3.0" v.c
Input/Output section	Input signal:	bal/unbal
	Input connectors:	XLR, RDNet Ethercon
	Output connectors:	XLR, RDNet Ethercon
	Input sensitivity:	+4 dBu
Processor section	Crossover Frequencies:	900Hz
	Protections:	Thermal, RMS
	Limiter:	Fast Limiter
	Controls:	Selectable preset, volume, delay
	RDNet:	Yes
Power section	Total Power:	3200 W Peak, 1600 W RMS
	High frequencies:	1200 W Peak, 600 W RMS
	Low frequencies:	2000 W Peak, 1000 W RMS
	Cooling:	Convection
	Connections:	Powercon IN/OUT
Standard compliance	CE marking:	Yes
Physical specifications	Cabinet/Case Material:	Baltic birch plywood
	Hardware:	Array fittings, 2xM10 on the top, 2xM8 on each side
	Handles:	2 Side, 2 Rear
	Pole mount/Cap:	Yes
	Grille:	Steel
	Color:	Black
Size	Height:	825 mm / 32.48 inches
	Width:	316 mm / 12.44 inches
	Depth:	369 mm / 14.53 inches
	Weight:	30.4 kg / 67.02 lbs
Shipping informations	Package Height:	410 mm / 16.14 inches
	Package Width:	865 mm / 34.06 inches
	Package Depth:	365 mm / 14.37 inches
	Package Weight:	33.5 kg / 73.85 lbs



PART NUMBER

- **13000604**

TTP 4-A

EAN 8024530017767

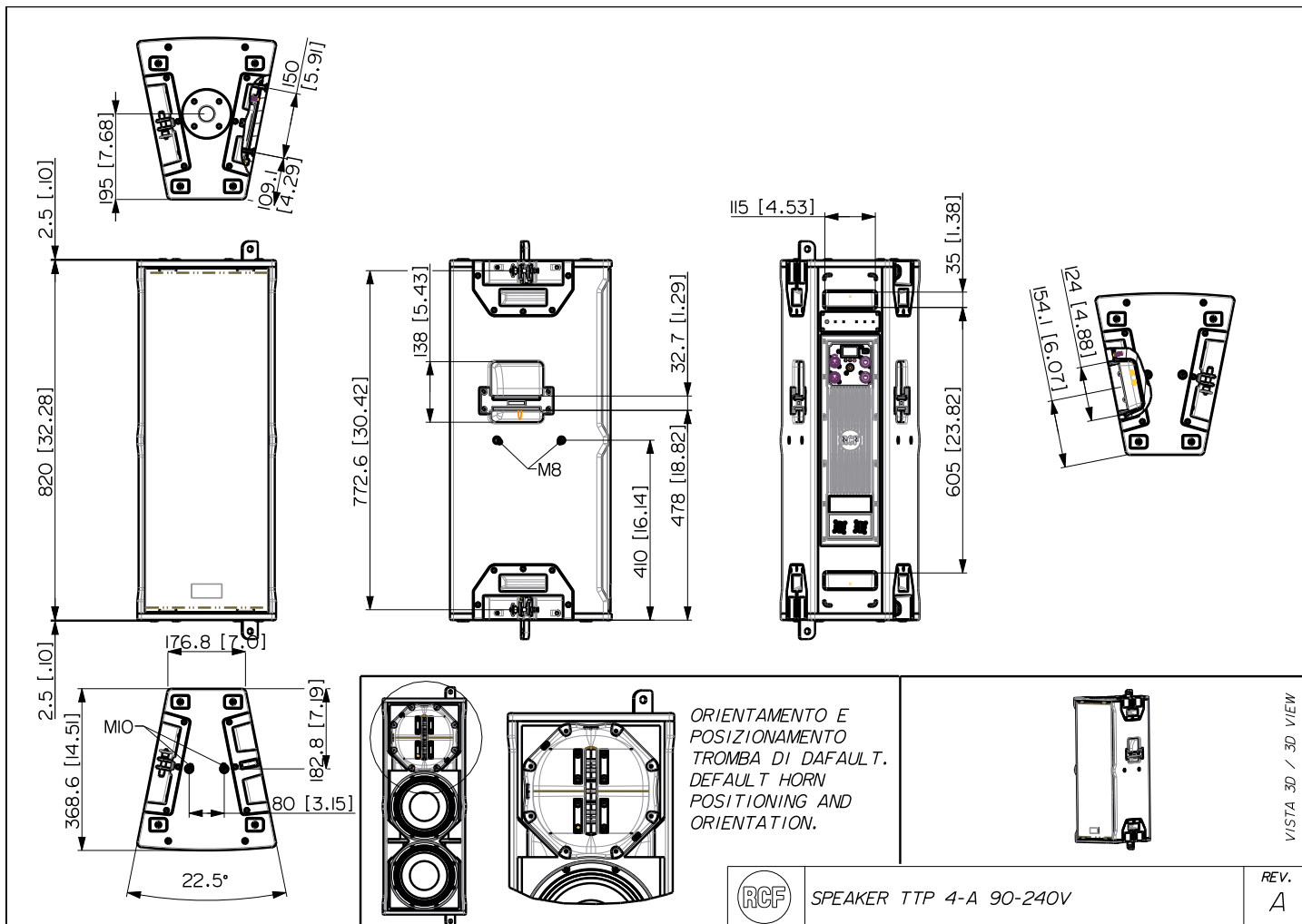

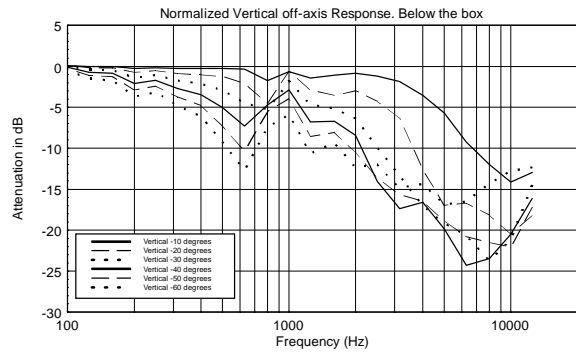
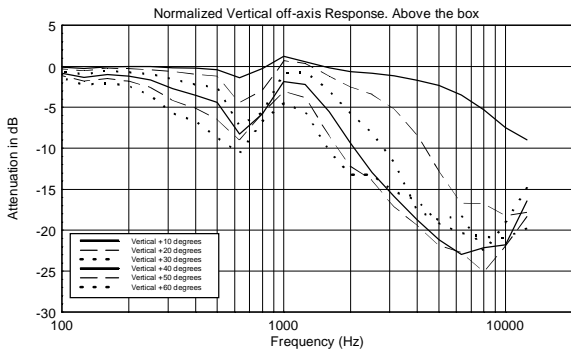
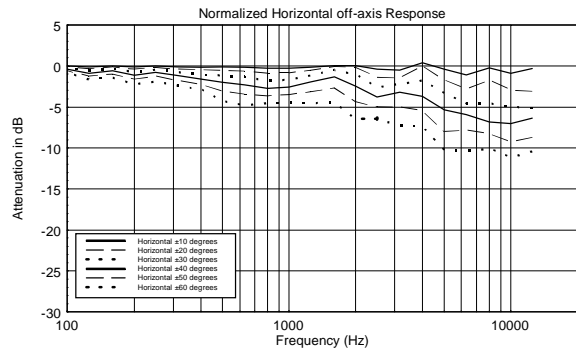
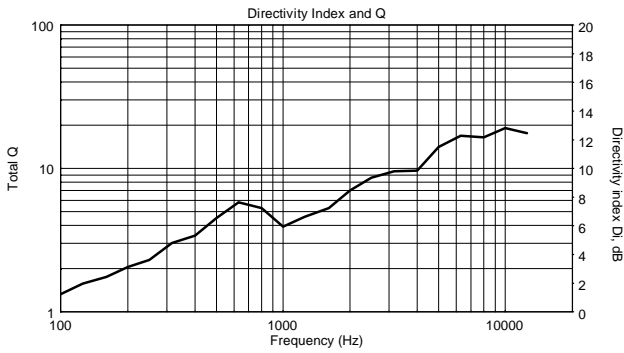
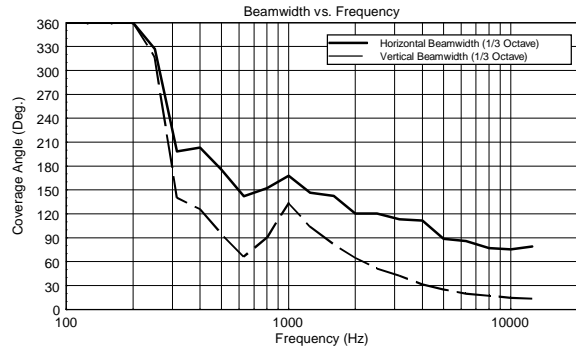
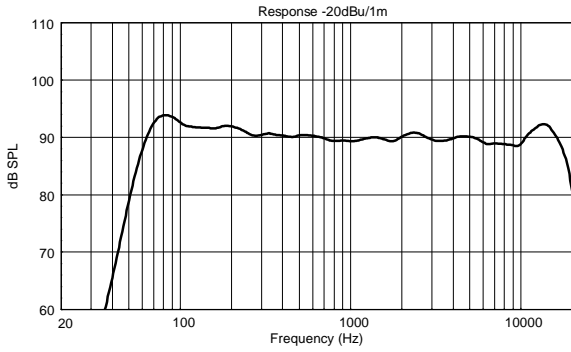

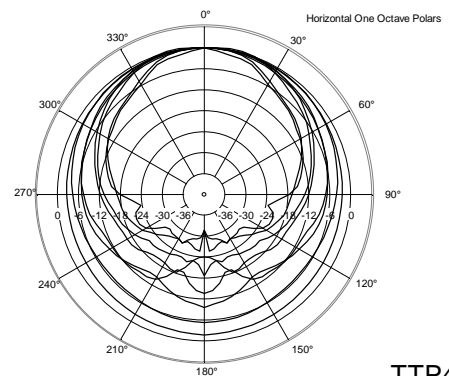
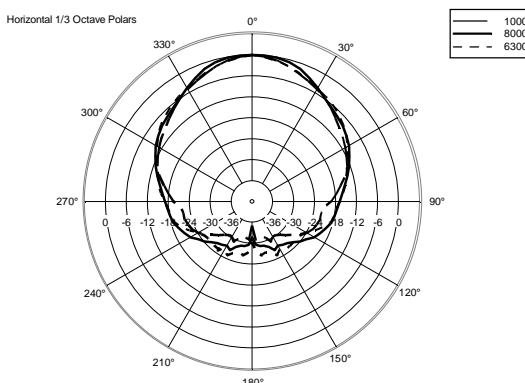
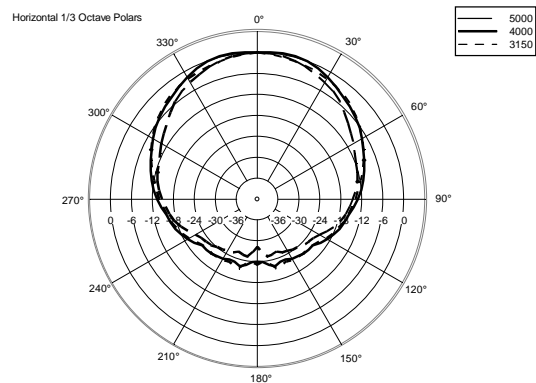
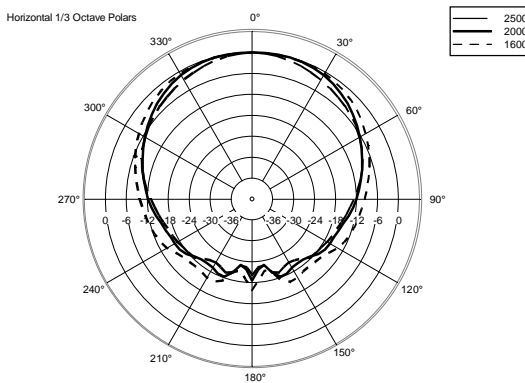
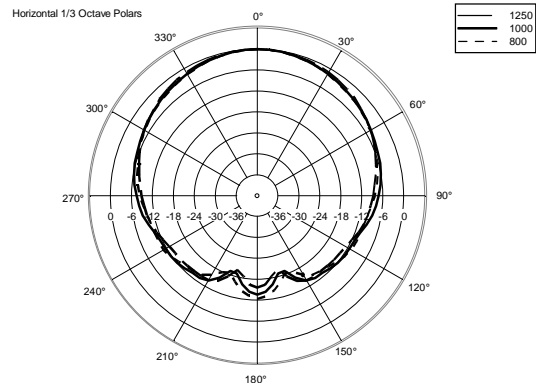
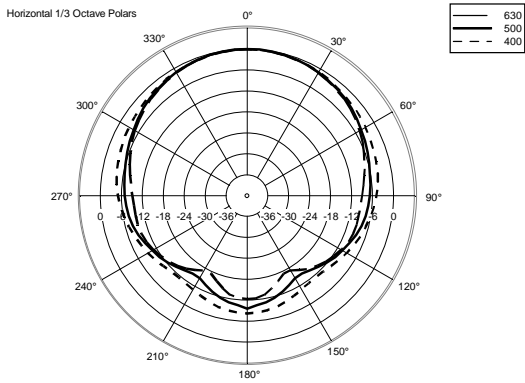
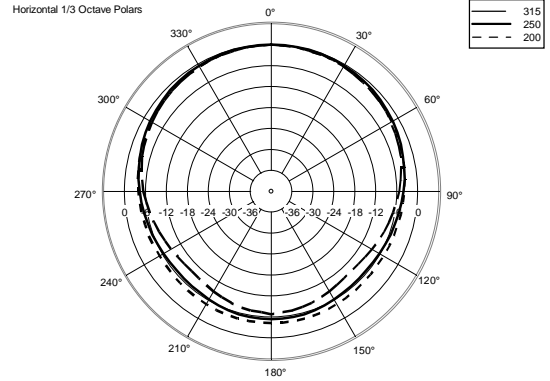
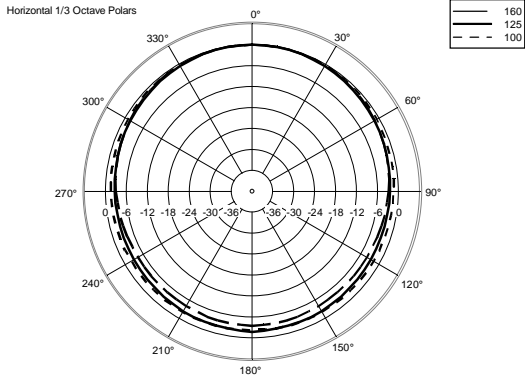

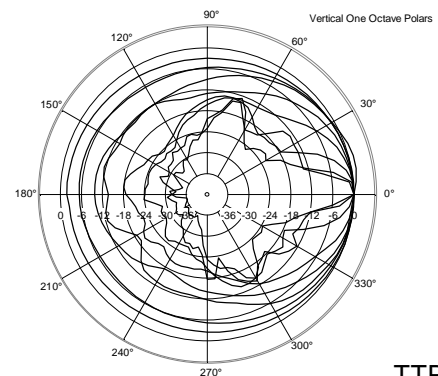
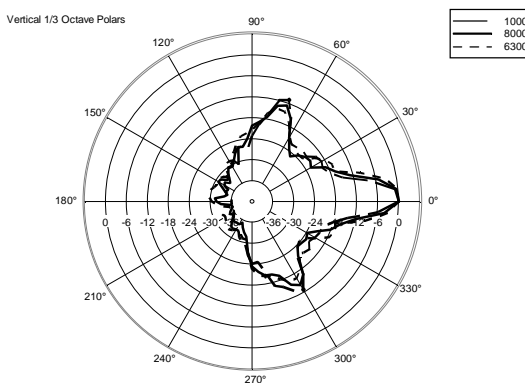
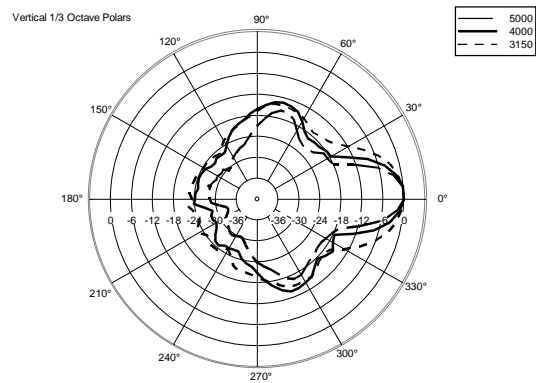
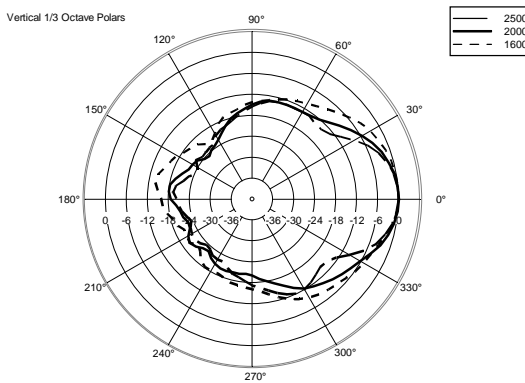
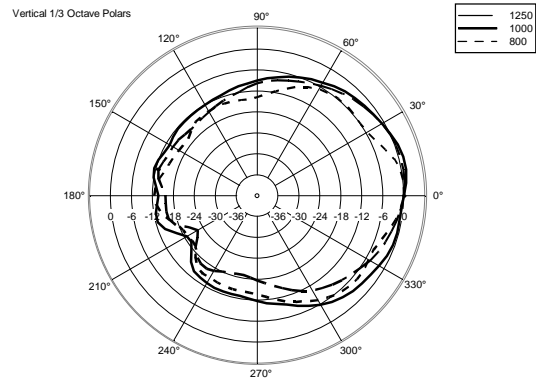
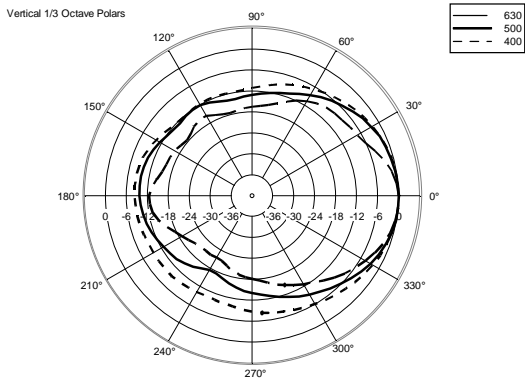
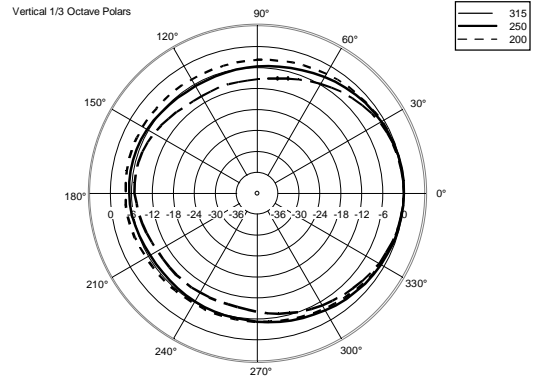
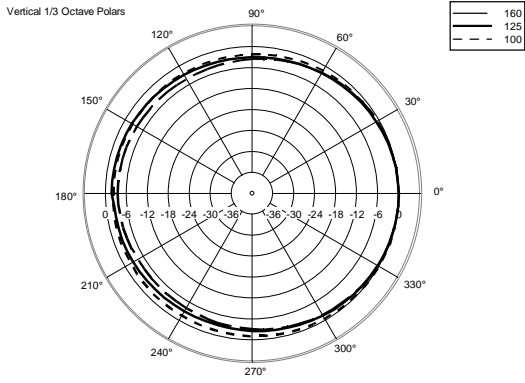

ACCESSORIES

AC PMX POLE MOUNT M20

PART NUMBER **13360232**
EAN: 8024530010058

AC PRO-FS PROFESS. LOCKING FLOOR STAND

PART NUMBER **13360109**
EAN: 8024530006471

AC PRO-PM PROFESS. LOCKING POLE MOUNT

PART NUMBER **13360110**
EAN: 8024530006488

CABLES KIT CBL ETHERCON 0.7M

PART NUMBER **12399016**
EAN: 8024530013844

CABLES KIT CBL ETHERCON 1.5M

PART NUMBER **12399017**
EAN: 8024530013851

CABLES KIT CBL ETHERCON 3M

PART NUMBER **12399035**
EAN: 8024530013868

CABLES KIT CBL ETHERCON 5M

PART NUMBER **12399018**
EAN: 8024530013875

CABLES KIT CBL ETHERCON TO XLR F 0.2M

PART NUMBER **12399019**
EAN: 8024530013882

CABLES KIT CBL ETHERCON TO XLR M 0.2M

PART NUMBER **12399020**
EAN: 8024530013899



CABLES KIT CBL POWERCON LINK 0.7M

PART NUMBER **12399031**
EAN: 8024530013738



CABLES KIT CBL POWERCON LINK 1.5M

PART NUMBER **12399030**
EAN: 8024530013721



COVER CVR TT 4

PART NUMBER **13360440**
EAN: 8024530017583



FLY BAR FL-B H TT 4

PART NUMBER **13360425**
EAN: 8024530018498



FLY BAR FL-B V TT 4

PART NUMBER **13360423**
EAN: 8024530017668



FLY BAR PICKUP FL-B PK HDL 6

PART NUMBER **13360372**
EAN: 8024530014353



LINK BAR FL-B LINK TT 4

PART NUMBER **13360428**
EAN: 8024530017620

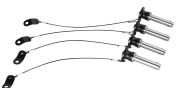

QUICK LOCK PIN QL-PIN D11.2 L31 4X

PART NUMBER **13360335**
EAN: 8024530013257



RAIN PROTECTION RP 1X HDL 30

PART NUMBER **13360388**
EAN: 8024530015138



VERTICAL BRACKET V-BR TT 4

PART NUMBER **13360427**
EAN: 8024530017637

