

TTL 33-A II WP STADIUM

ACTIVE THREE-WAY LINE ARRAY MODULE

DESCRIPTION

The TTL 33-A II WP STADIUM is a full range, ultra-compact, wide dispersion line array module that sets a new standard in the TT+ Stadia sound reinforcement, offering substantial power and efficiency for a variety of professional outdoor applications, including stadia, sports arenas, concert halls and other fixed venue installations.

Loudspeakers are strengthened with a special waterproof film and a multi-layer coating on the grille, that is highly resistant to humidity, but transparent to sound.



FEATURES

- Effective 1250W switching power supply
- 6 high-power neodymium transducers
- Weatherproof touring-grade Baltic birch cabinet
- RDNet compatible
- IP 67 connectors
- Lightweight anti-hygroscopic resin on transducers
- Amplifier, DSP and connections protected against humidity
- Safe rigging and hanging
- Real-time monitoring and control exceeding EN60849 requirements
- Front-grille designed for outdoor applications

TECHNICAL SPECIFICATIONS

Acoustical specifications	Frequency Response:	60 Hz ÷ 20000 Hz
	Max SPL @ 1m:	135 dB
	Horizontal coverage angle:	100°
	Vertical coverage angle:	15°
Transducers	Compression Driver:	3 x 1.0" neo, 1.5" v.c
	Midrange:	8" neo, 2.0" v.c
	Woofer:	2 x 8" neo, 2.5" v.c
Input/Output section	Input signal:	bal/unbal
	Input connectors:	XLR, RDNet Ethercon
	Output connectors:	XLR, RDNet Ethercon
	Input sensitivity:	-2 dBu/+4 dBu
Processor section	Crossover Frequencies:	400 Hz - 1800 Hz
	Protections:	Thermal, HF
	Limiter:	Fast Limiter
	Controls:	HF Correction, cluster size, HPF
	RDNet:	Yes
Power section	Total Power:	2500 W Peak, 1250 W RMS
	High frequencies:	500 W Peak, 250 W RMS
	Mid frequencies:	1000 W Peak, 500 W RMS
	Low frequencies:	1000 W Peak, 500 W RMS
	Cooling:	Convection/Forced
	Connections:	Powercon IN/OUT
Standard compliance	CE marking:	Yes
Physical specifications	Cabinet/Case Material:	Baltic birch plywood
	Hardware:	Array side fittings screws (8 per side rear)
	Grille:	Steel
	Color:	Black
Size	Height:	300 mm / 11.81 inches
	Width:	760 mm / 29.92 inches
	Depth:	450 mm / 17.72 inches
	Weight:	33 kg / 72.75 lbs
Shipping informations	Package Height:	395 mm / 15.55 inches
	Package Width:	875 mm / 34.45 inches
	Package Depth:	545 mm / 21.46 inches
	Package Weight:	37 kg / 81.57 lbs



PART NUMBER

- **13000402**

TTL 33-A II WP STADIUM

220-240V

EAN 8024530010577

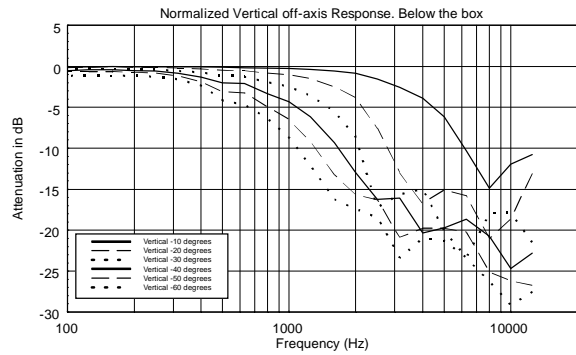
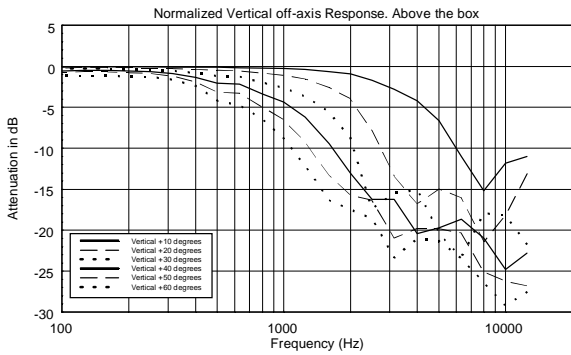
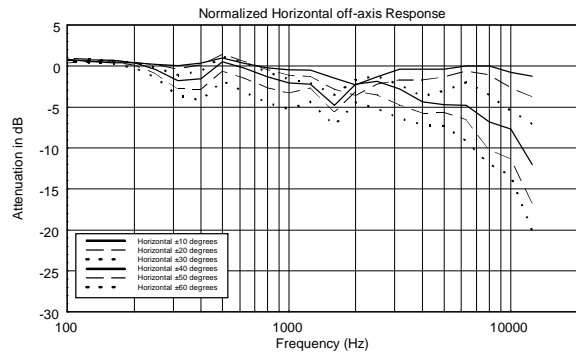
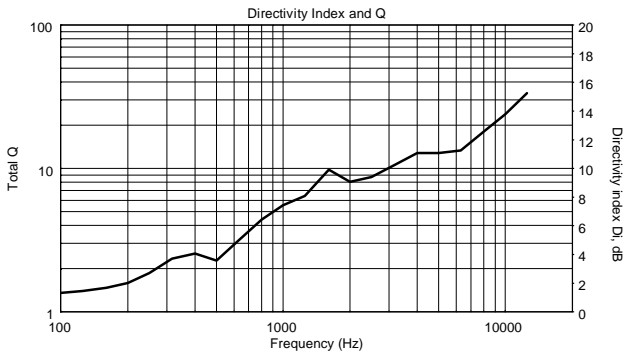
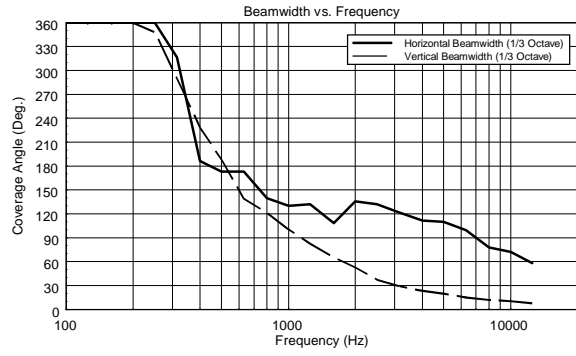
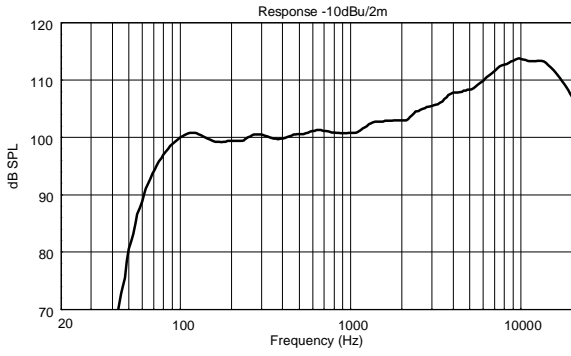

Horizontal 1/3 Octave Polars

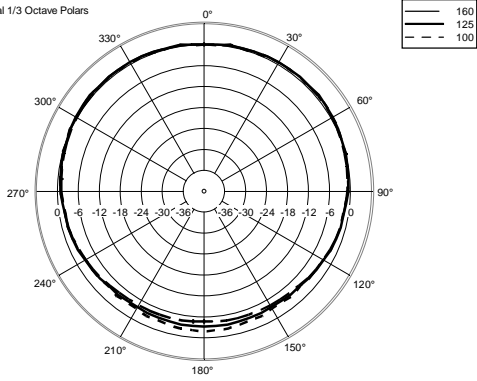

Horizontal 1/3 Octave Polars

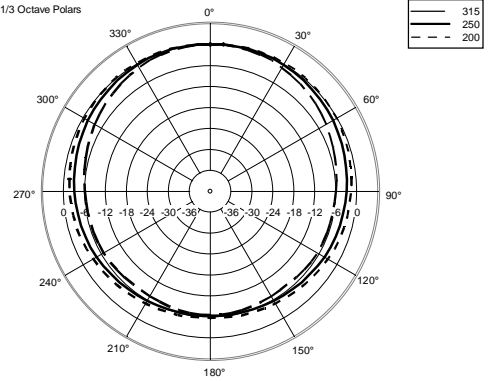

Horizontal 1/3 Octave Polars

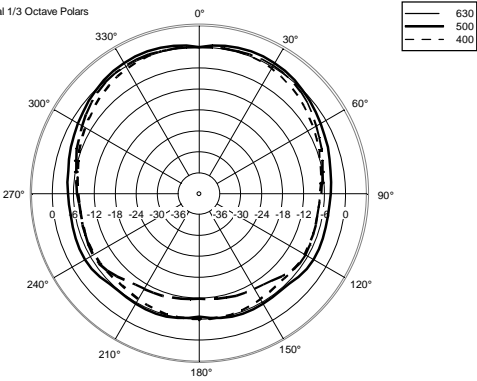

Horizontal 1/3 Octave Polars

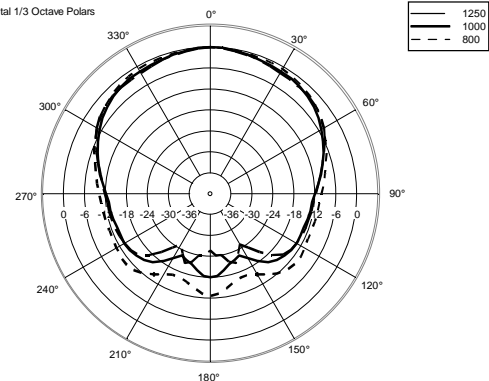

Horizontal 1/3 Octave Polars

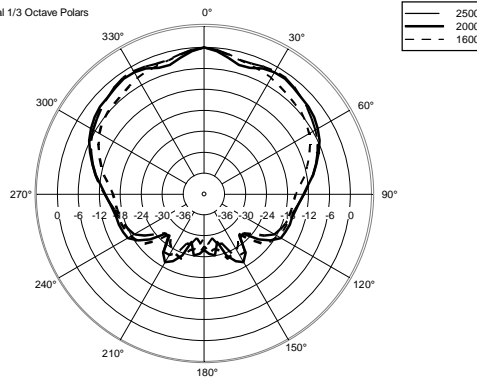

Horizontal 1/3 Octave Polars

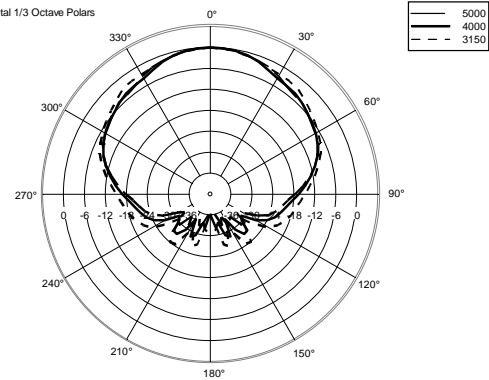

Horizontal 1/3 Octave Polars

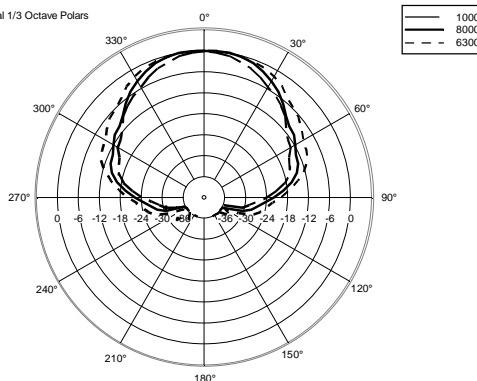

Horizontal One Octave Polars

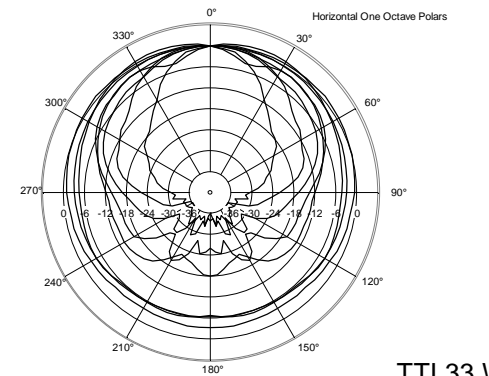

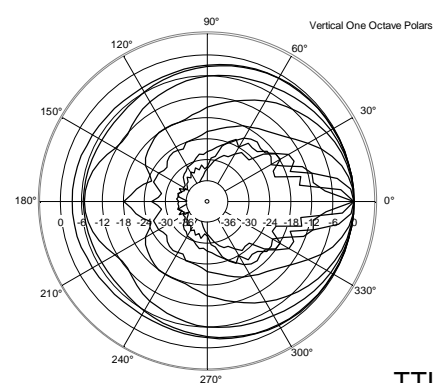
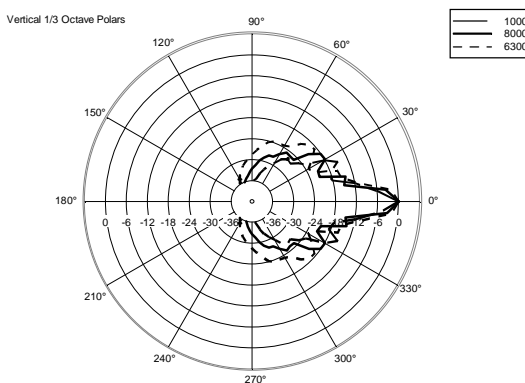
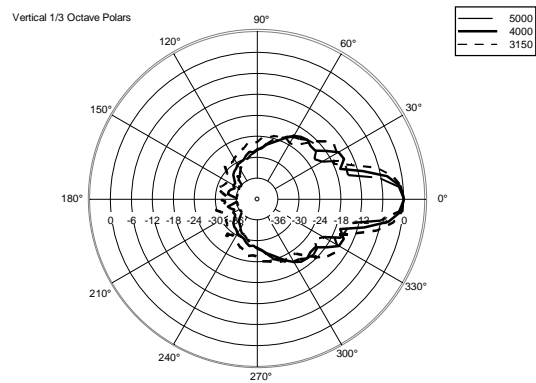
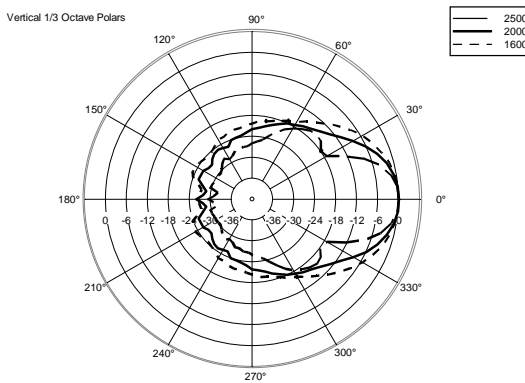
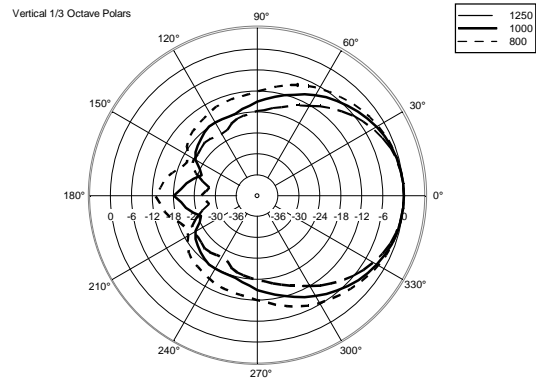
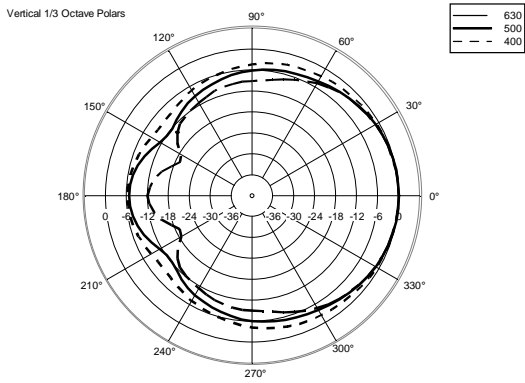
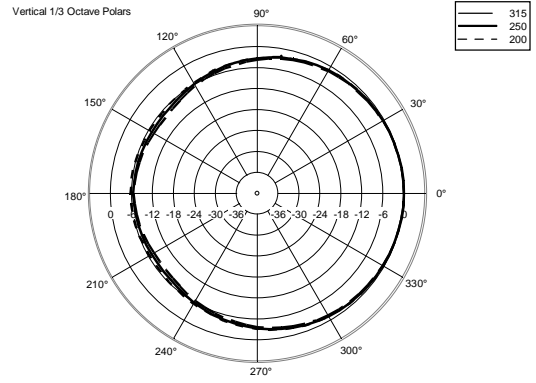
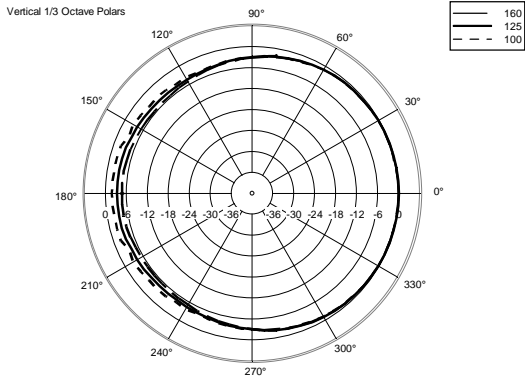



ACCESSORIES