

# TT 10-A

## ACTIVE TWO-WAY HIGH DEFINITION SPEAKER

### DESCRIPTION

With 130 dB SPL power and a small footprint, the active two-way RCF TT10-A speaker saves the day when you need top quality sound power and unobtrusive size. Though remarkably compact and lightweight, the TT10-A offers the distinguished high-end TT+ sound quality, DSP capabilities, networked control, rugged hardware and a complete set of rigging options.



### FEATURES

- 130 dB SPL Max
- 1000W RMS, two-way Class-D amplifier
- Rotatable 90° x 70° Constant Directivity Horn
- Quick Fit Bracket Socket
- FiRPHASE
- 10" neodymium Woofers, 2.5" voice coil
- Horn-loaded 1" neo comp. driver, 1,75" voice coil
- RDNet Networked Management
- 60 ÷ 20000 Hz Frequency Range

## TECHNICAL SPECIFICATIONS

<b>Acoustical specifications</b>	Frequency Response:	60 Hz ÷ 20000 Hz
	Max SPL @ 1m:	130 dB
	Horizontal coverage angle:	90°
	Vertical coverage angle:	70°
<b>Transducers</b>	Compression Driver:	1.0" neo, 1.75" v.c
	Woofers:	10" neo, 2.5" v.c
<b>Input/Output section</b>	Input signal:	bal/unbal
	Input connectors:	XLR, RDNet Ethercon
	Output connectors:	XLR, RDNet Ethercon
	Input sensitivity:	-2 dBu/+4 dBu
<b>Processor section</b>	Crossover Frequencies:	900 Hz
	Protections:	Thermal, HF
	Limiter:	Fast Limiter
	Controls:	Bypass, Linear/High Pass, Volume, RDnet on board
	RDNet:	Yes
<b>Power section</b>	Total Power:	2000 W Peak, 1000 W RMS
	High frequencies:	600 W Peak, 300 W RMS
	Low frequencies:	1400 W Peak, 700 W RMS
	Cooling:	Convection
	Connections:	Powercon IN/OUT
<b>Standard compliance</b>	CE marking:	Yes
<b>Physical specifications</b>	Cabinet/Case Material:	Baltic birch plywood
	Hardware:	3X M10 TOP AND BOTTOM 2X PIN D.10 AND M10 SIDE
	Handles:	1 TOP
	Grille:	Steel
	Color:	Black
<b>Size</b>	Height:	490 mm / 19.29 inches
	Width:	306 mm / 12.05 inches
	Depth:	299 mm / 11.77 inches
	Weight:	11.5 kg / 25.35 lbs
<b>Shipping informations</b>	Package Height:	540 mm / 21.26 inches
	Package Width:	350 mm / 13.78 inches
	Package Depth:	350 mm / 13.78 inches
	Package Weight:	15.6 kg / 34.39 lbs



**PART NUMBER**

- **13000559**

TT 10-A

115V

EAN 8024530017200

- **13000549**

TT 10-A

220-240V

EAN 8024530017125

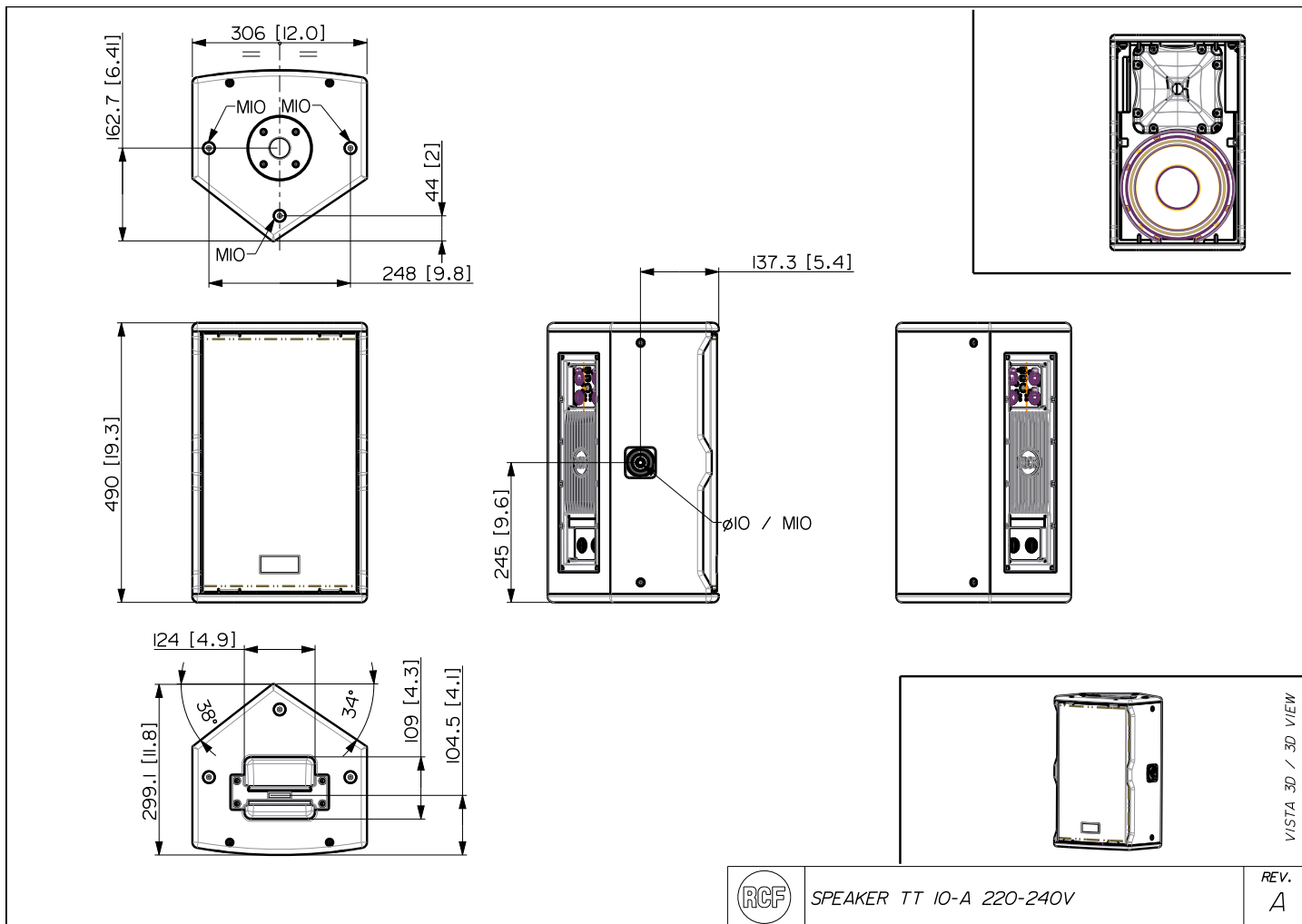

SPEAKER TT 10-A 220-240V

REV. A

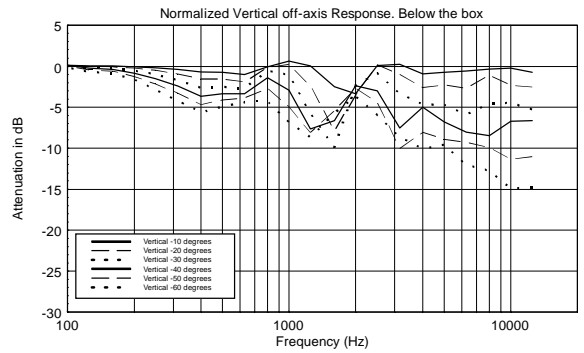
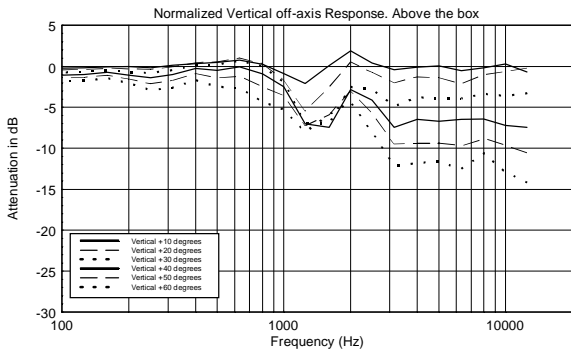
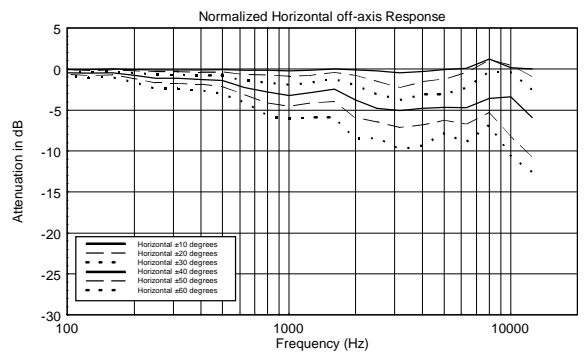
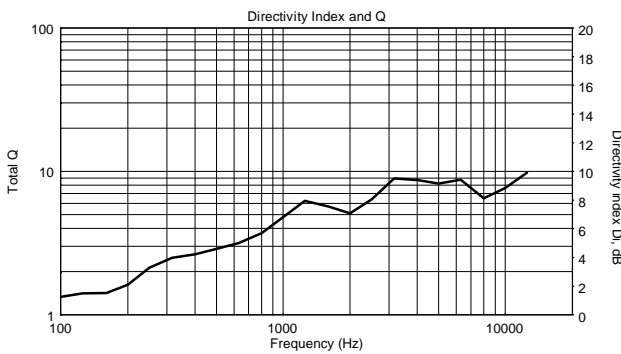
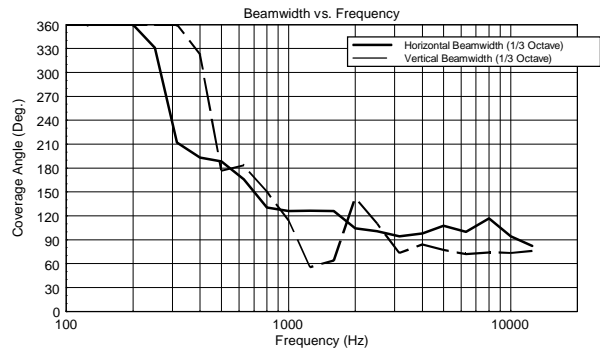
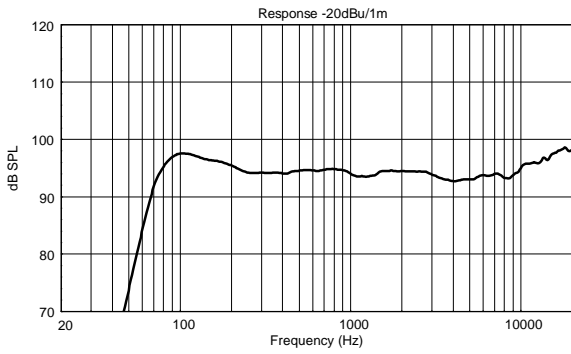

Horizontal 1/3 Octave Polars

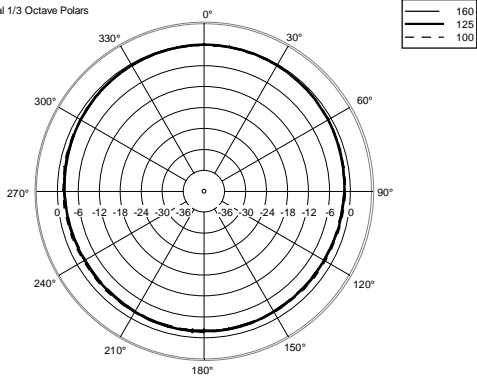

Horizontal 1/3 Octave Polars

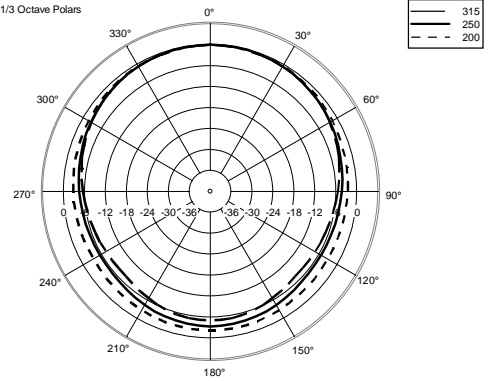

Horizontal 1/3 Octave Polars

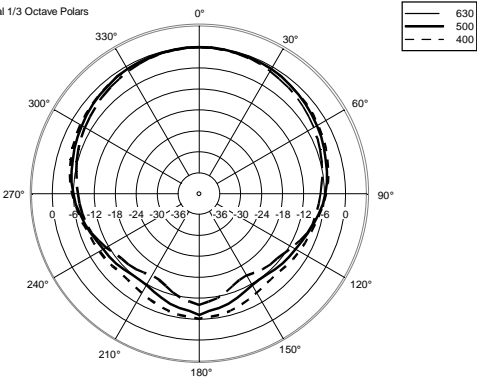

Horizontal 1/3 Octave Polars

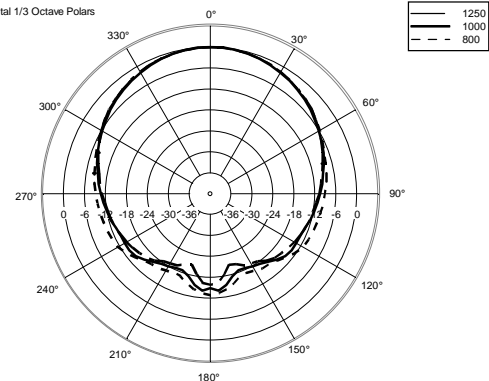

Horizontal 1/3 Octave Polars

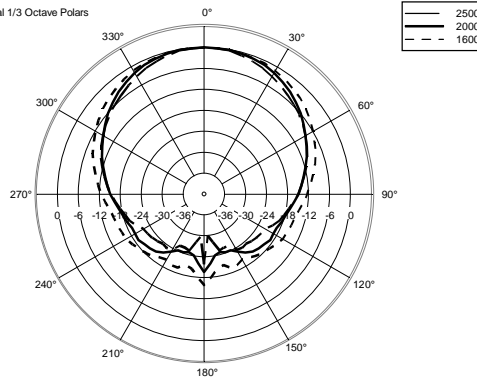

Horizontal 1/3 Octave Polars

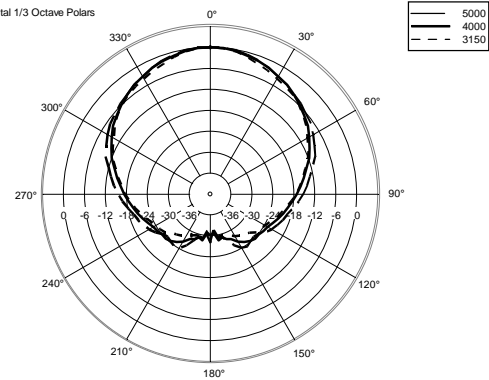

Horizontal 1/3 Octave Polars

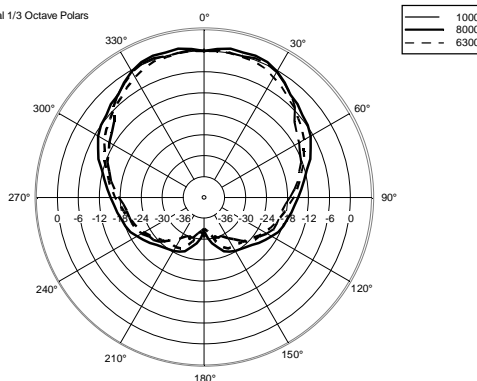



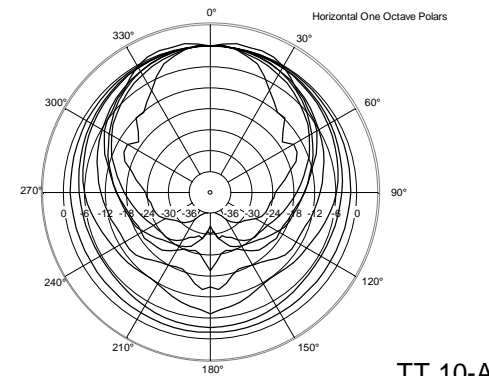

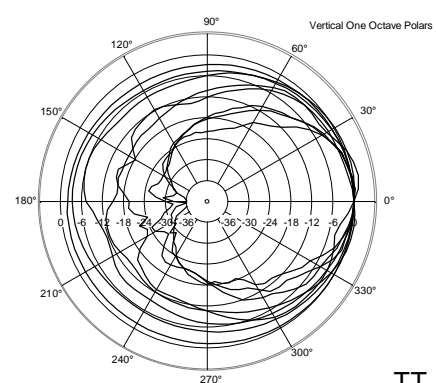
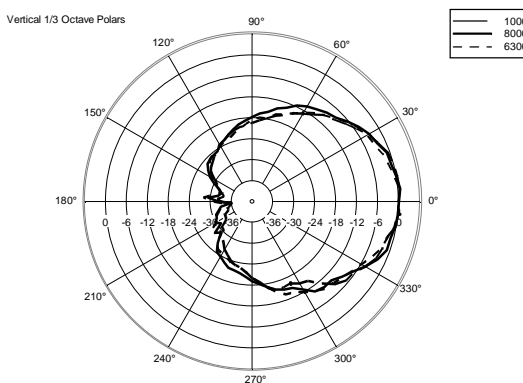
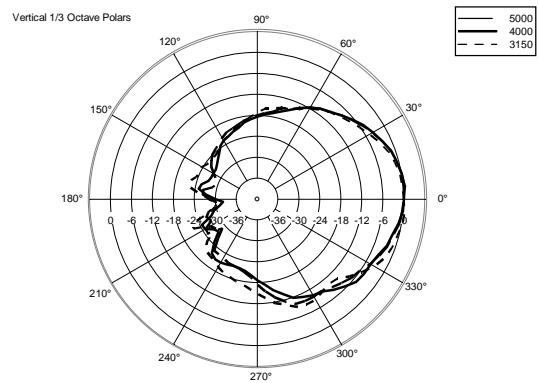
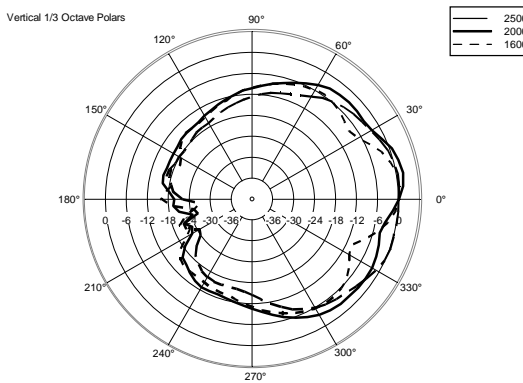
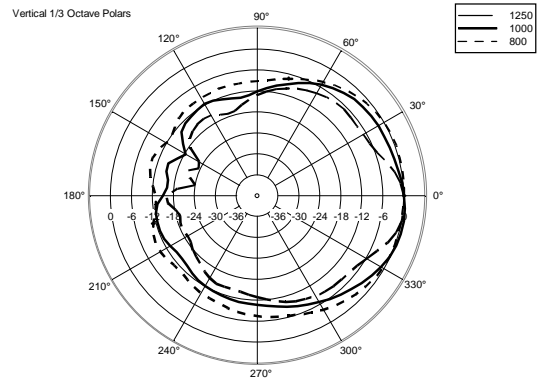
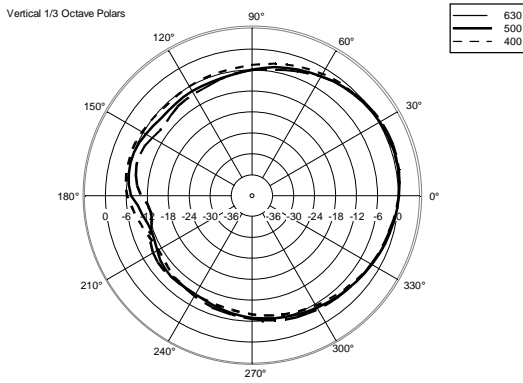
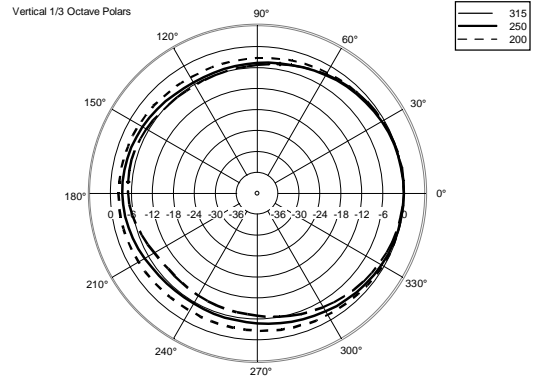
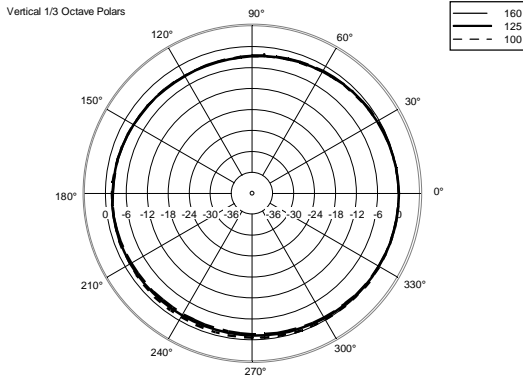



Horizontal One Octave Polars





**ACCESSORIES**

	AC PMA - POLE MOUNT	PART NUMBER EAN:	<b>13360034</b> 8024530007713
	AC PM-M20	PART NUMBER EAN:	<b>13360067</b> 8024530014599
	AC PMX POLE MOUNT M20	PART NUMBER EAN:	<b>13360232</b> 8024530010058
	AC PRO-FS PROFESS. LOCKING FLOOR STAND	PART NUMBER EAN:	<b>13360109</b> 8024530006471
	AC PRO-PM PROFESS. LOCKING POLE MOUNT	PART NUMBER EAN:	<b>13360110</b> 8024530006488
	COVER CVR TT 10	PART NUMBER EAN:	<b>13360404</b> 8024530016333
	HORIZONTAL BRACKET H-BR TT 10	PART NUMBER EAN:	<b>13360402</b> 8024530016319
	KIT EYEBOLT 4 X	PART NUMBER EAN:	<b>13360031</b> 8024530018870
	RAIN PROTECTION RP 1X HDL 6	PART NUMBER EAN:	<b>13360381</b> 8024530015169





VERTICAL BRACKET V-BR TT 10

PART NUMBER **13360401**  
EAN: 8024530016302

---