

NXL 24-A MK2

ACTIVE TWO-WAY ARRAY

DESCRIPTION

NXL 24-A MK2 is a line array column speaker masterfully engineered from the ground up to deliver stellar audio performance for Bands, DJs, Clubs, and Rental Companies. The best-in-class combination of premium RCF transducers and a 2100W two-channel amplifier produce coherent 100° x 30° coverage for the listening area with up to 132 dB. The two-way design features four 6" neodymium woofers and a 3" driver on an asymmetrical waveguide. The horn's design delivers accurate sound to the coverage area without tilting the enclosure. The speaker delivers an extended frequency range down to 60 Hz and can be used as a stand-alone speaker, flown, or coupled with another NXL 24-A MK2 for extended coverage. Pairing the speaker with subwoofers delivers full-range power for medium-sized concerts and DJ systems. Blending RCF proprietary FiRPHASE and Bass Motion Control DSP processing, the NXL 24-A MK2 speaker is perfectly tuned for absolute sound clarity and deep, powerful bass response. The rugged, tour-ready, high-quality baltic birch plywood cabinet is easy to carry and installed securely using the dedicated rigging points.

FEATURES

- Up to 132 dB Sound Pressure Level
- 2100W Class-D Amplifier
- 100° x 30° Constant Directivity Coverage Angle
- 3" Titanium Neodymium Compression Driver
- 4 x 6" High Power Neodymium Woofers
- 60-20000 Hz linear Frequency Response
- Bass Motion Control and FiRPHASE processing
- 4 x M8 Rigging Points and 4 x Quick Lock



TECHNICAL SPECIFICATIONS

Acoustical specifications	Frequency Response:	60 Hz ÷ 20000 Hz
	Max SPL @ 1m:	132 dB
	Horizontal coverage angle:	100°
	Vertical coverage angle:	30°
Transducers	Compression Driver:	1 x 1.4" neo, 3.0" v.c
	Woofers:	4 x 6.0" neo, 1.5" v.c
Input/Output section	Input signal:	bal/unbal
	Input connectors:	Combo XLR/Jack
	Output connectors:	XLR
	Input sensitivity:	+4 dBu
Processor section	Crossover Frequencies:	800
	Protections:	Thermal, Excurs., RMS
	Limiter:	Soft Limiter
	Controls:	Linear, 2 Speakers, High-Pass, Volume
Power section	Total Power:	2100 W Peak
	High frequencies:	700 W Peak
	Low frequencies:	1400 W Peak
	Cooling:	Convection
	Connections:	Powercon TRUE1 TOP IN/OUT
Standard compliance	CE marking:	Yes
Physical specifications	Cabinet/Case Material:	Baltic birch plywood
	Hardware:	4 x M8, 4 x quick lock
	Handles:	2 side
	Pole mount/Cap:	Yes
	Grille:	Steel
	Color:	Black
Size	Height:	1056 mm / 41.57 inches
	Width:	201 mm / 7.91 inches
	Depth:	274 mm / 10.79 inches
	Weight:	24.4 kg / 53.79 lbs
Shipping informations	Package Height:	320 mm / 12.6 inches
	Package Width:	1080 mm / 42.52 inches
	Package Depth:	230 mm / 9.06 inches
	Package Weight:	27.5 kg / 60.63 lbs



PART NUMBER

- **13000751**

NXL 24-A MK2

115V

EAN 8024530019877

- **13000610**

NXL 24-A MK2

220-240V

EAN 8024530019884

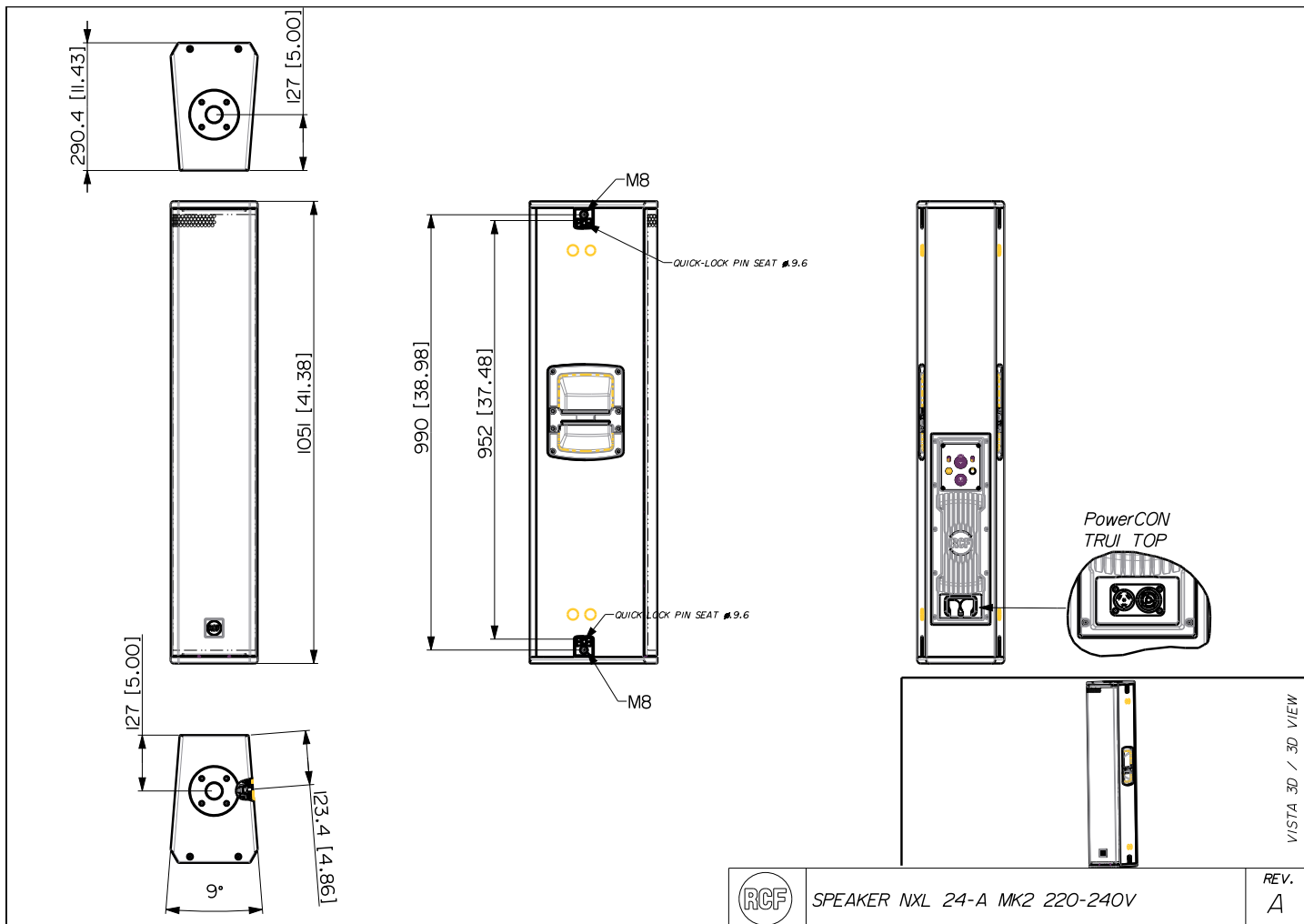

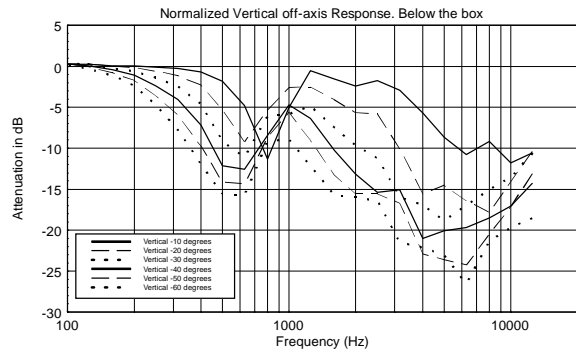
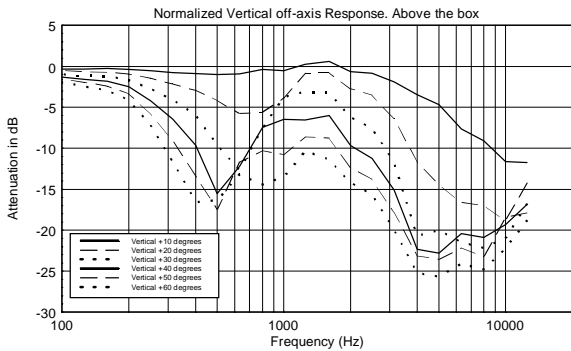
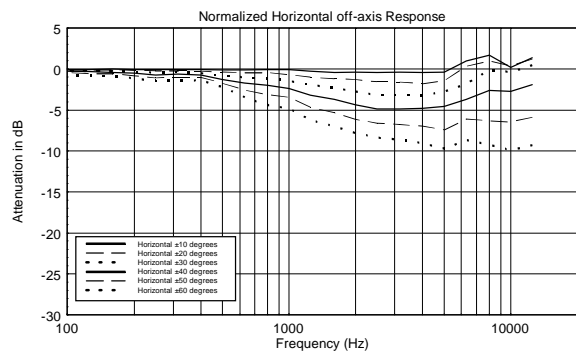
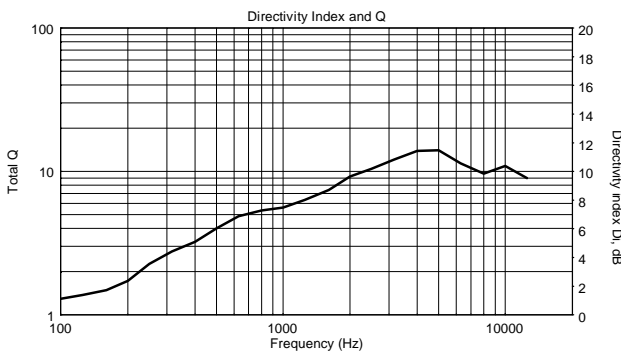
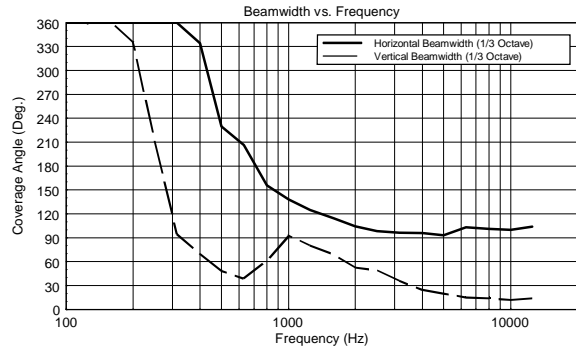
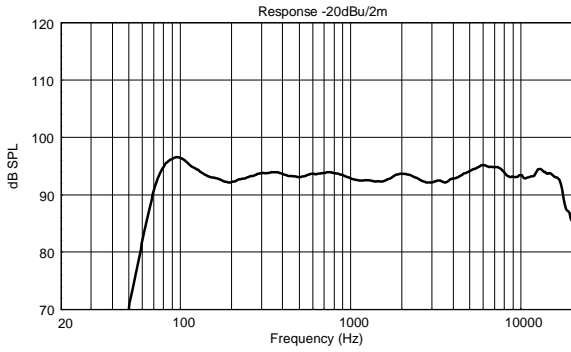

Horizontal 1/3 Octave Polars

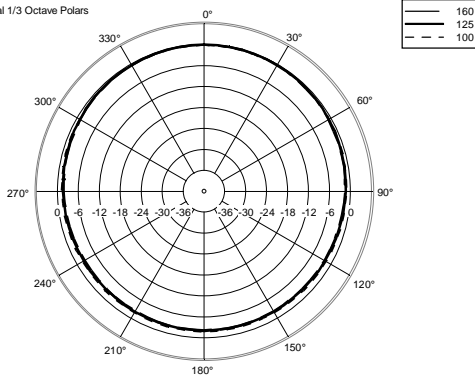

Horizontal 1/3 Octave Polars

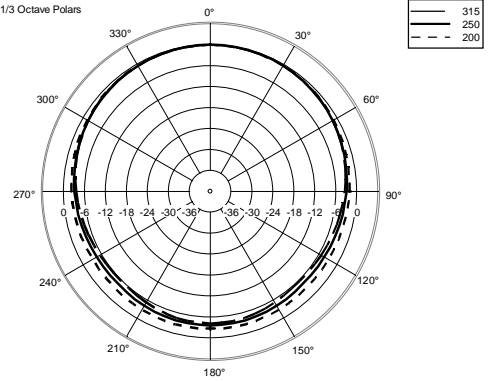

Horizontal 1/3 Octave Polars

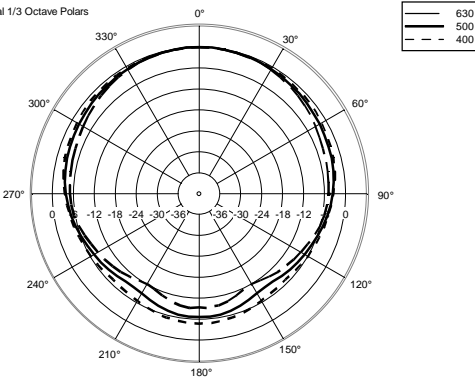

Horizontal 1/3 Octave Polars

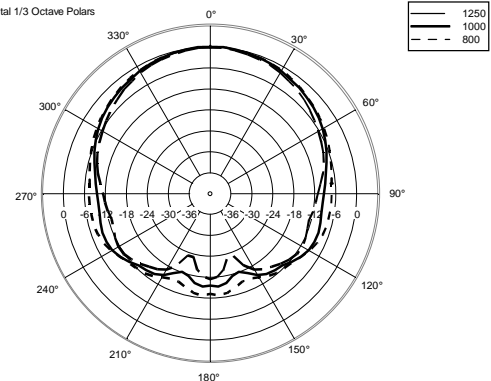

Horizontal 1/3 Octave Polars

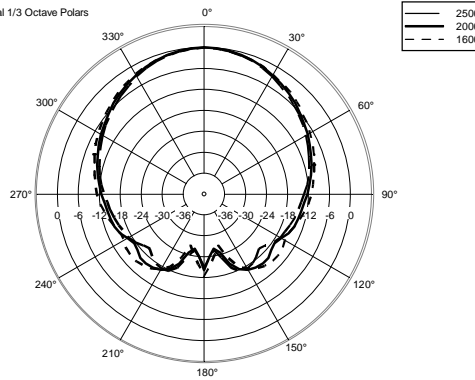

Horizontal 1/3 Octave Polars

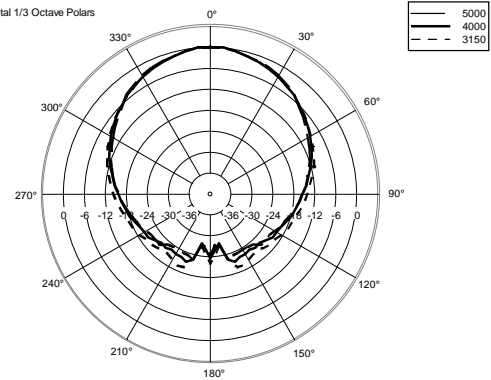

Horizontal 1/3 Octave Polars

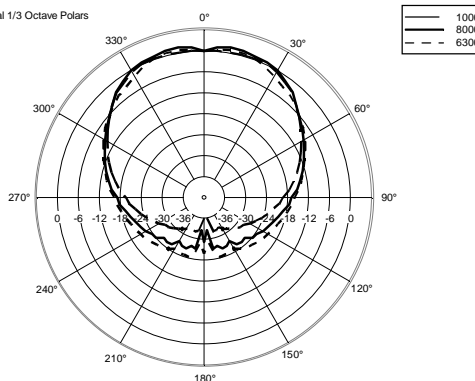



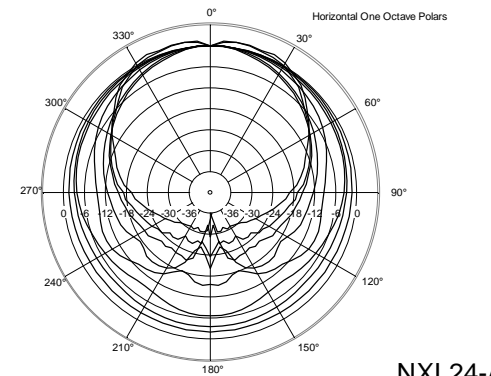

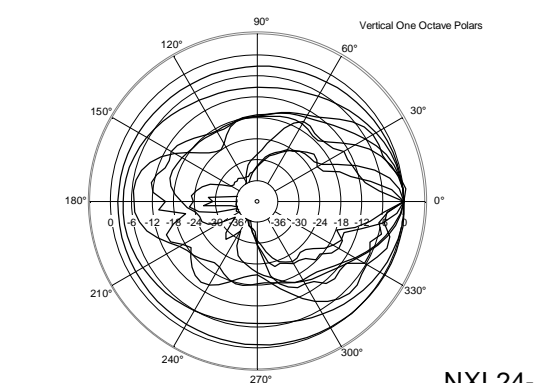
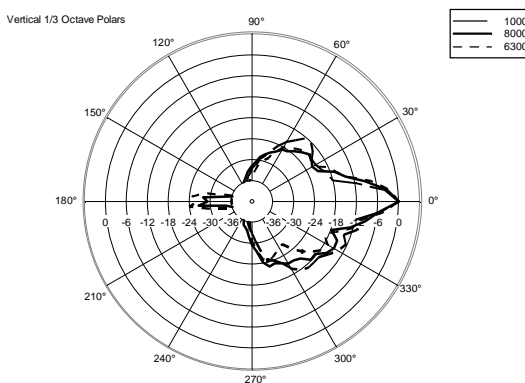
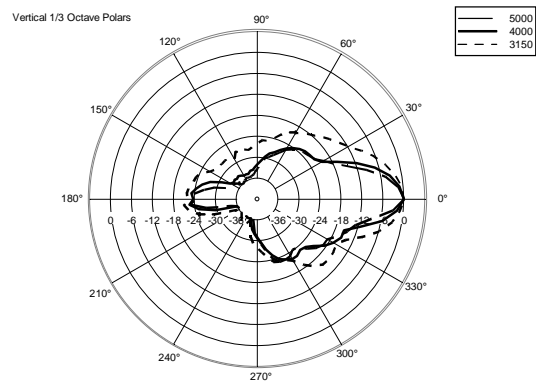
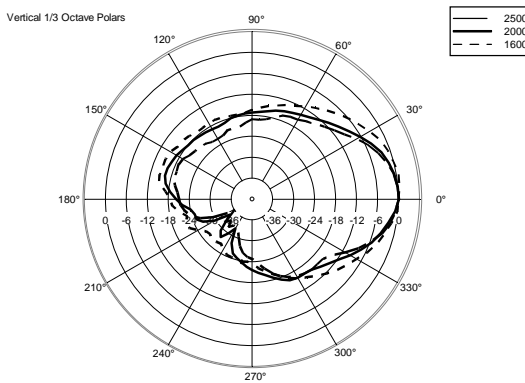
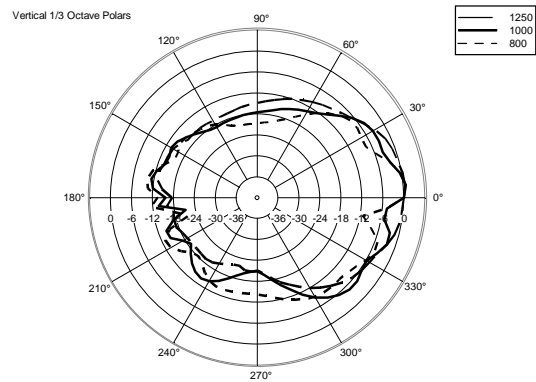
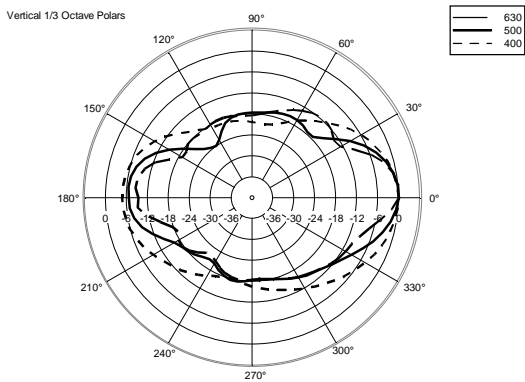
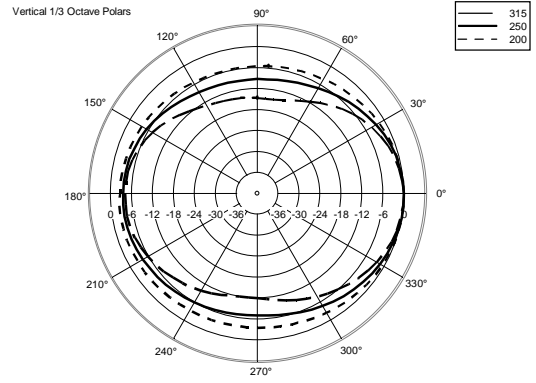
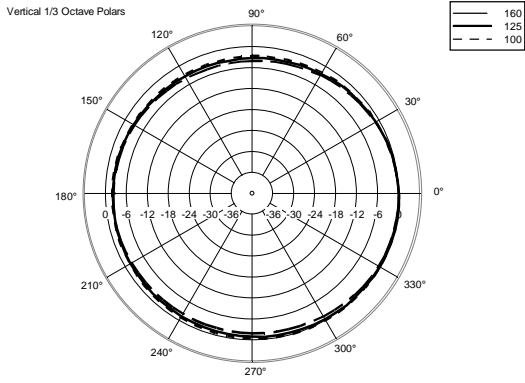



Horizontal One Octave Polars





ACCESSORIES

	AC PMA - POLE MOUNT	PART NUMBER EAN:	13360034 8024530007713
	AC PM-M20	PART NUMBER EAN:	13360067 8024530014599
	AC PMX POLE MOUNT M20	PART NUMBER EAN:	13360232 8024530010058
	AC PRO-FS PROFESS. LOCKING FLOOR STAND	PART NUMBER EAN:	13360109 8024530006471
	AC PRO-PM PROFESS. LOCKING POLE MOUNT	PART NUMBER EAN:	13360110 8024530006488
	FLY BAR FL-B NXL 24	PART NUMBER EAN:	13360278 8024530015756
	LINK BAR FL-B LINK NXL 24	PART NUMBER EAN:	13360279 8024530016487
	POLE MOUNT KIT NXL24-A	PART NUMBER EAN:	13360280 8024530018665
	STACKING KIT NXL24-A	PART NUMBER EAN:	13360281 8024530018689