

HD 10-A MK4

ACTIVE TWO-WAY SPEAKER

DESCRIPTION

RCF cares about your sound. The new D-Line MK4 speakers boosts the performance with a series of brand new transducers, improves the sound quality with the revolutionary FiRPHASE processing and renew the grille design to exalt the professional look. The vocals are natural, the sound is clear at long distances, the SPL power is stable at very high levels.

The concept of the HD-Line derives from the touring industry, bringing in an elegant and compact cabinet all the experience of RCF professional sound with the maximum reliability and strength for the intensive use on the road. Connect your microphone, your device or your mixer to the speaker and turn up the volume: real plug&play. Perfect as a main front of house in small PA systems, high powered floor monitoring and unobtrusive fixed installation.



FEATURES

- 800 watt 2-way peak power
- 128 dB max SPL
- Digital bi-amplification, SMPS
- DSP sound processing
- 90° x 70°, wide dispersion constant directivity horn
- 10" woofer, high power, 2.0" voice coil
- 1.0" HF driver, titanium dome, neodymium 1.0" voice coil
- FiRPHASE processing

TECHNICAL SPECIFICATIONS

Acoustical specifications	Frequency Response:	50 Hz ÷ 20000 Hz
	Max SPL @ 1m:	128 dB
	Horizontal coverage angle:	90°
	Vertical coverage angle:	60°
Transducers	Compression Driver:	1.0", 1.75" v.c
	Woofers:	10", 2.0" v.c
Input/Output section	Input signal:	bal/unbal
	Input connectors:	XRL, Jack
	Output connectors:	XLR
	Input sensitivity:	-2 dBu/+4 dBu
	Mic. Input Sensitivity:	-32 dBu
Processor section	Crossover Frequencies:	2000 Hz
	Protections:	Thermal, RMS
	Limiter:	Soft Limiter
	Controls:	Boost, Volume, Mic/Line
Power section	Total Power:	800 W Peak, 400 W RMS
	High frequencies:	200 W Peak, 100 W RMS
	Low frequencies:	600 W Peak, 300 W RMS
	Cooling:	Convection
	Connections:	VDE
Standard compliance	CE marking:	Yes
Physical specifications	Cabinet/Case Material:	PP Composite
	Hardware:	1 x M10 top, 1 x M10 bottom, 3 x M6 bottom
	Handles:	1 Top, 1 Side
	Pole mount/Cap:	Yes
	Grille:	Steel
	Color:	Black
Size	Height:	527 mm / 20.75 inches
	Width:	303 mm / 11.93 inches
	Depth:	303 mm / 11.93 inches
	Weight:	11.8 kg / 26.01 lbs
Shipping informations	Package Height:	640 mm / 25.2 inches
	Package Width:	400 mm / 15.75 inches
	Package Depth:	380 mm / 14.96 inches
	Package Weight:	14 kg / 30.86 lbs



PART NUMBER

• **13040025**

HD 10-A MK4

115V

EAN 8024530014094

• **13040024**

HD 10-A MK4

220-240V

EAN 8024530014087

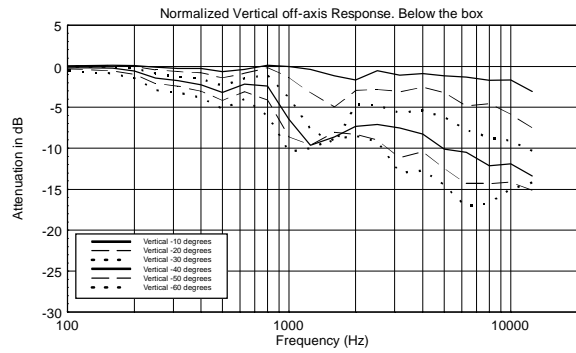
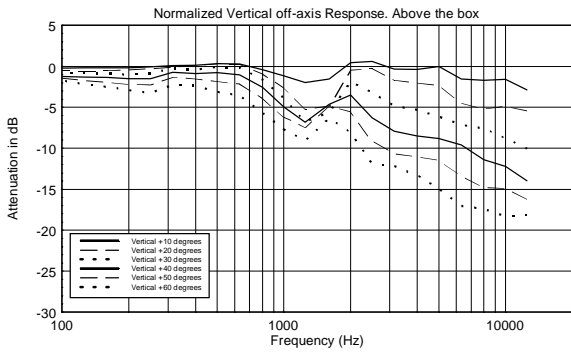
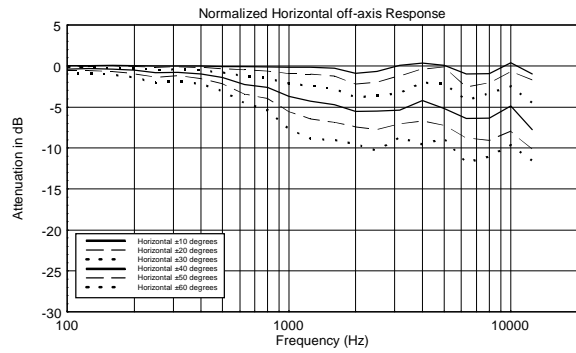
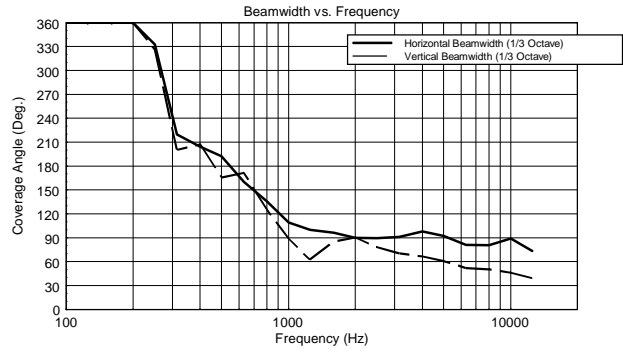
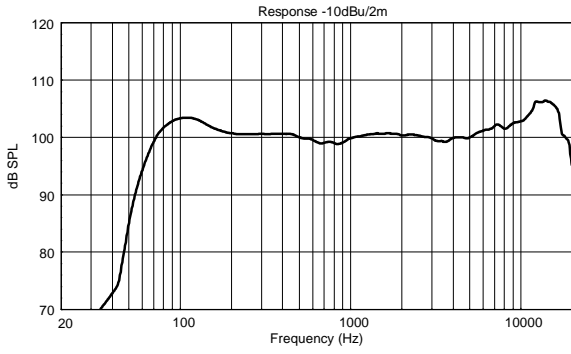

Horizontal 1/3 Octave Polars

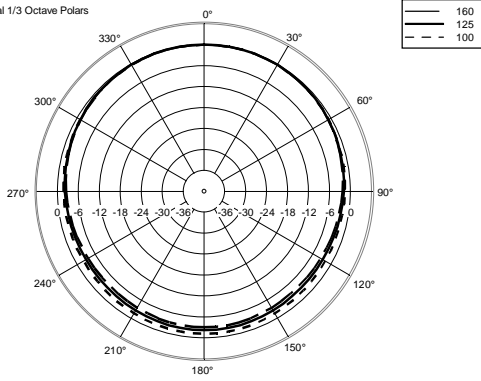

Horizontal 1/3 Octave Polars

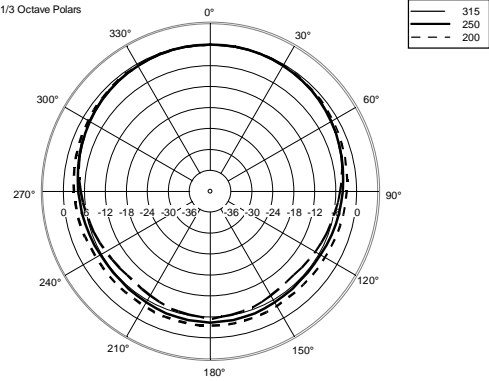

Horizontal 1/3 Octave Polars

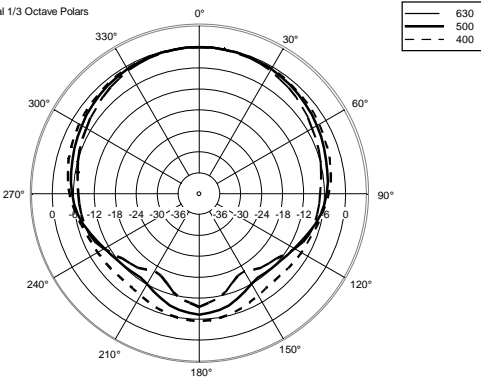

Horizontal 1/3 Octave Polars

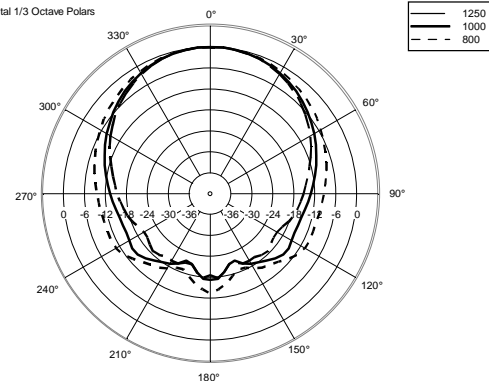

Horizontal 1/3 Octave Polars

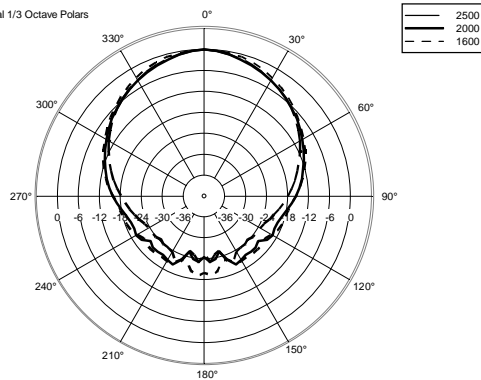

Horizontal 1/3 Octave Polars

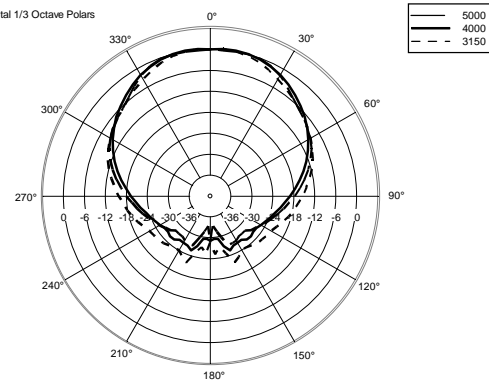

Horizontal 1/3 Octave Polars

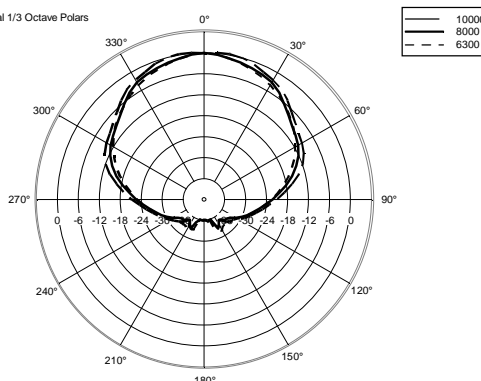

Horizontal One Octave Polars

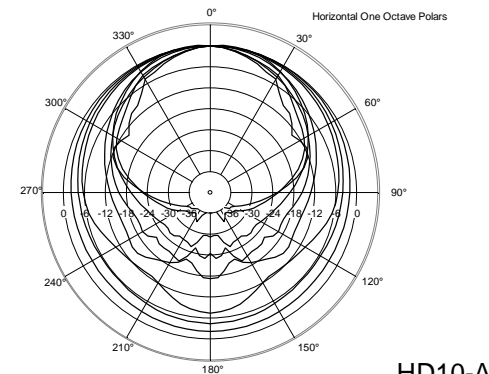

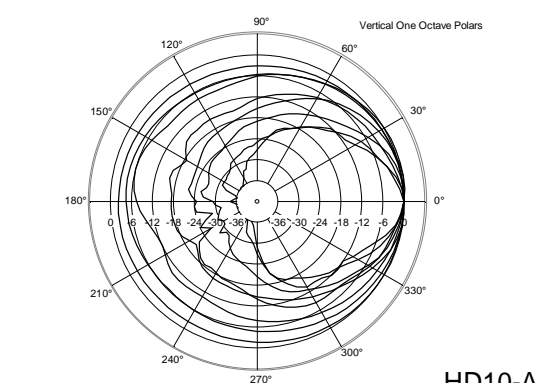
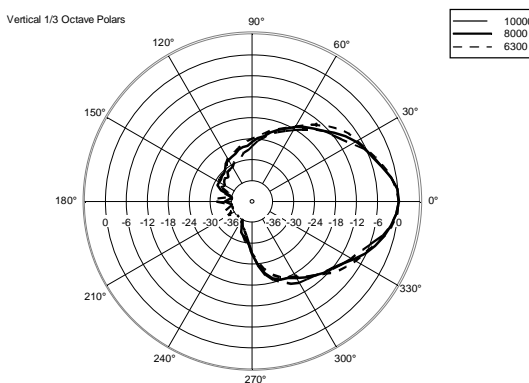
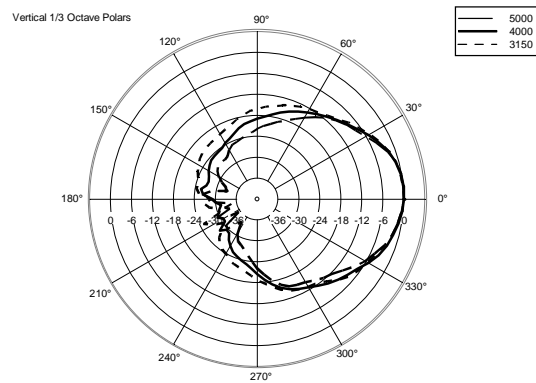
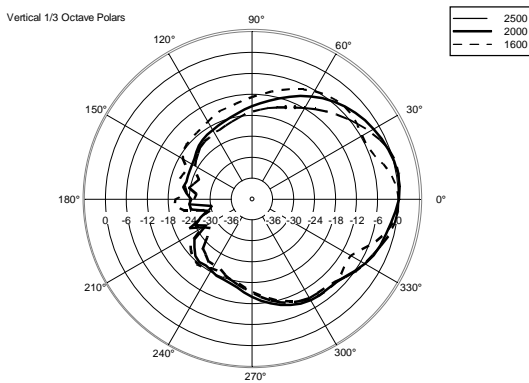
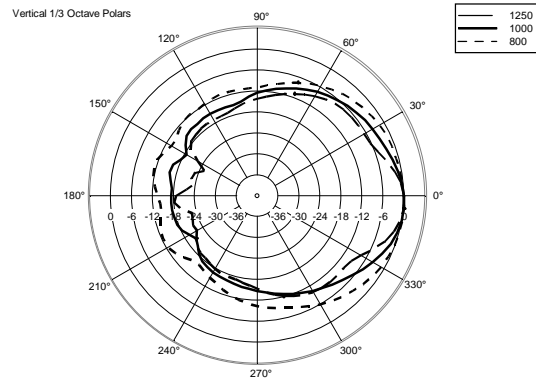
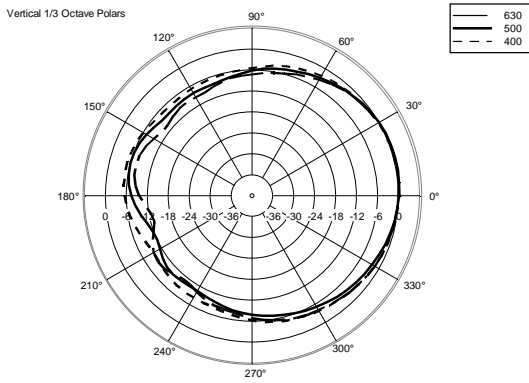
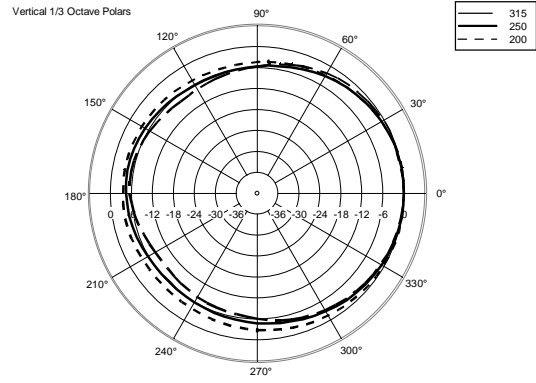
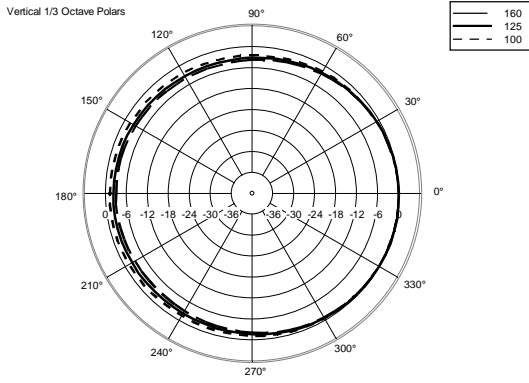

ACCESSORIES

	AC PMA - POLE MOUNT	PART NUMBER EAN:	13360034 8024530007713
	AC PM-M20	PART NUMBER EAN:	13360067 8024530014599
	AC PMX POLE MOUNT M20	PART NUMBER EAN:	13360232 8024530010058
	AC PRO-FS PROFESS. LOCKING FLOOR STAND	PART NUMBER EAN:	13360109 8024530006471
	AC PRO-LF PROFESSIONAL LOCKING FLANGE	PART NUMBER EAN:	13360111 8024530006495
	AC PRO-PM PROFESS. LOCKING POLE MOUNT	PART NUMBER EAN:	13360110 8024530006488
	AC XLR-3M3F XLR CONN. 3MALE3FEMALEXCABLE	PART NUMBER EAN:	13360102 8024530006402
	COVER CVR HD 10	PART NUMBER EAN:	13360208 8024530010713
	HORIZONTAL BRACKET H-BR 2X HD 10	PART NUMBER EAN:	13360215 8024530016548



SPEAKER CABINET FLOOR STAND-STEEL

PART NUMBER **13360035**

EAN: 8024530005030
