

P 6215

WEATHERPROOF COAXIAL TWO-WAY SPEAKER

DESCRIPTION

The P 6215 is a weatherproof full range, wide-dispersion, coaxial two-way loudspeaker system for very high output and long-throw applications. The speaker can be installed individually or coupled in array configurations. The low-frequency transducer is a 15" neodymium woofer, the high-frequency section combines a 1.3" neodymium RCF Precision compression driver with a 2.5" diaphragm assembly centrally mounted in the throat of the LF driver and loaded on a constant directivity CMD horn for smooth, wide dispersion. Internal circuit provides low crossover frequency for accurate vocal intelligibility and Active Mosfet Compression Driver Protection (AMCDP). The single-piece roto-molded cabinet is fully UV protected and meets IP-55 standard requirements, equipped with M10 brass inserts (12x), and one durable and corrosion-resistant 316P stainless steel U-Bracket with f spacers (2x) for 90° mounting. The aluminum grille cover is powder coated with water-repellent backing material and has a rotatable logo plate.



FEATURES

- 134 dB SPL Max, 600W RMS
- Weatherproof IP55 cabinet with UV protection
- Rotomoulded cabinet available in white or black
- 60° x 60° conical CMD horn
- One 15" high-output neodymium LF transducer
- One RCF Precision 2.5" neodymium C. Driver
- Active Mosfet Compression Driver Protection
- 12 brass suspension points (M10)

TECHNICAL SPECIFICATIONS

Acoustical specifications

Frequency Response (-10dB):	75 Hz ÷ 20000 Hz
Max SPL @ 1m:	134 dB
Horizontal coverage angle:	60°
Vertical coverage angle:	60°
Directivity index Q:	13
System Sensitivity:	100 dB

Power section

Nominal Impedance:	8 ohm
Power Handling:	600 W
Peak Power Handling:	2400 W PEAK
Recommended Amplifier:	1200 W
Protections:	Dynamic active mosfet
Crossover Frequencies:	1100 Hz

Transducers

Compression Driver:	Coaxial 1.3" neo, 2.5" v.c
Woofers:	Coaxial 15" neo, 3.0" v.c

Input/Output section

Input connectors:	Neoprene Cable
-------------------	----------------

Standard compliance

IP protection grade:	IP 55
CE marking:	Yes

Physical specifications

Cabinet/Case Material:	PE Low Density
Hardware:	12 x M10 + U-Bracket and Pair of spacers
Grille:	Aluminum with waterproof clothing
Color:	Grey, White - RAL 9003

Size

Height:	463 mm / 18.23 inches
Width:	463 mm / 18.23 inches
Depth:	433 mm / 17.05 inches
Weight:	17 kg / 37.48 lbs

Shipping informations

Package Height:	519 mm / 20.43 inches
Package Width:	489 mm / 19.25 inches
Package Depth:	489 mm / 19.25 inches
Package Weight:	21.4 kg / 47.18 lbs

PART NUMBER

• **13100083**

P 6215 W

EAN 8024530017521

• **13000131**

P 6215

EAN 8024530008260

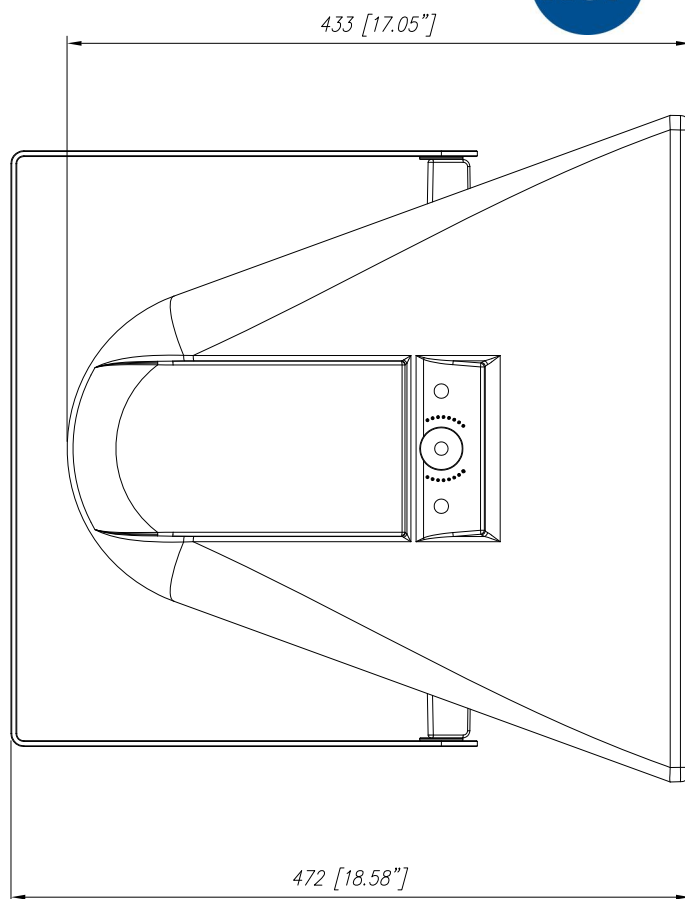
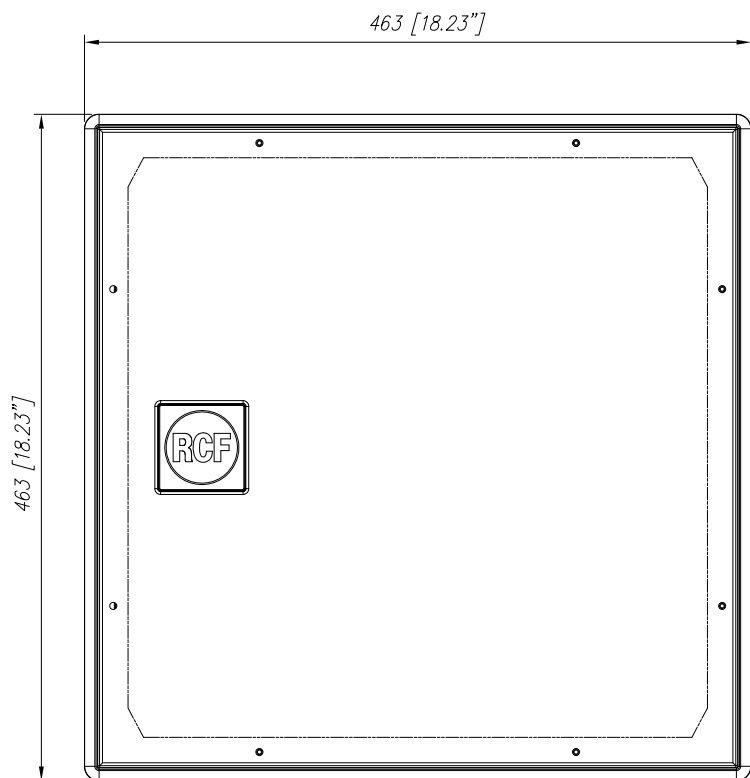

P3115

P6215

P8015

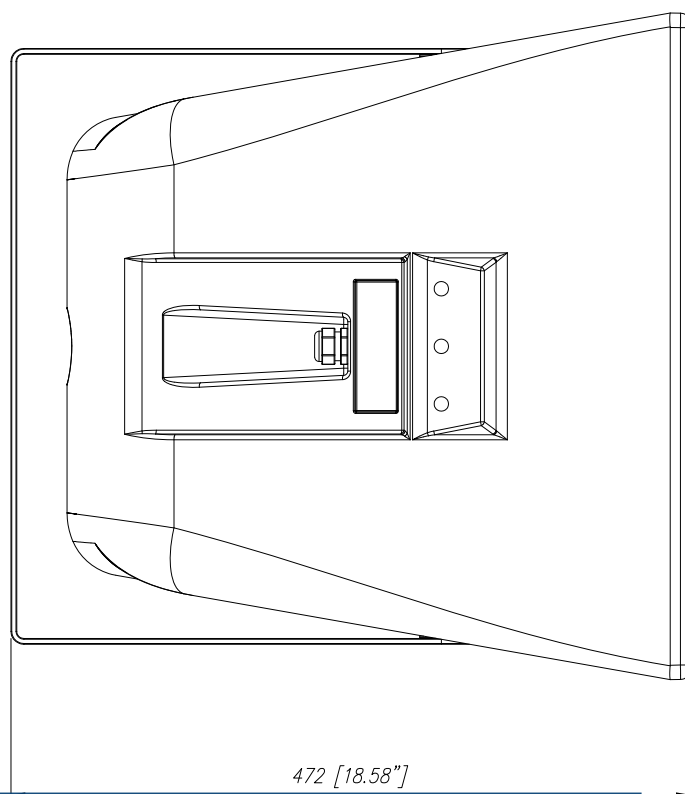

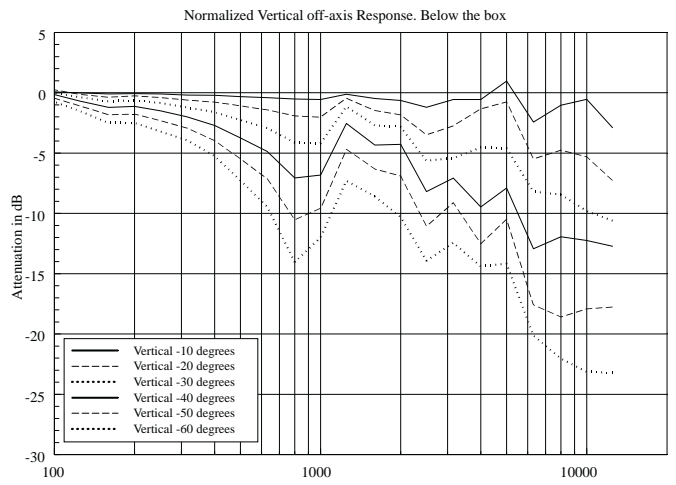
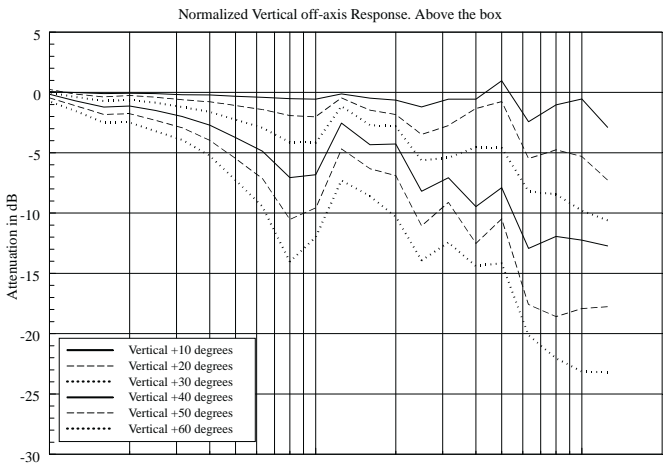
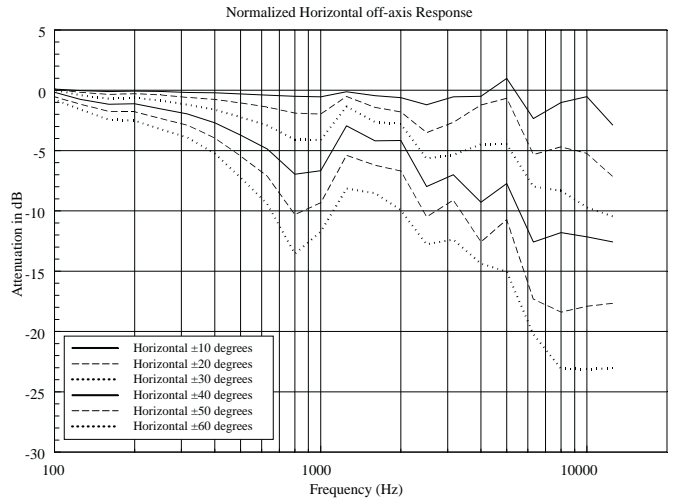
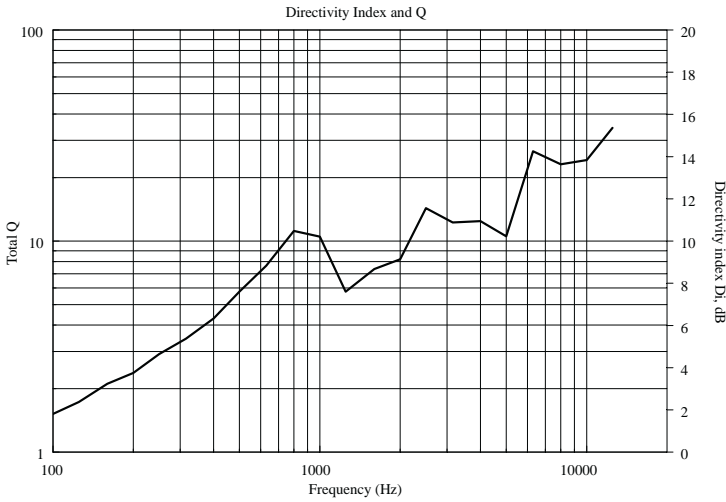
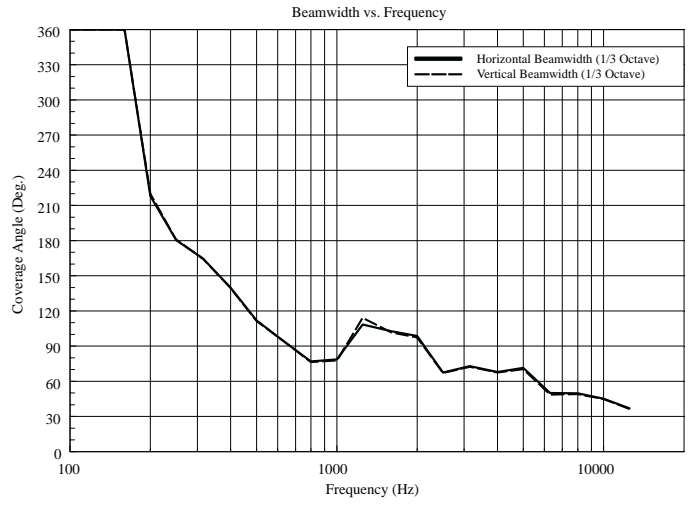
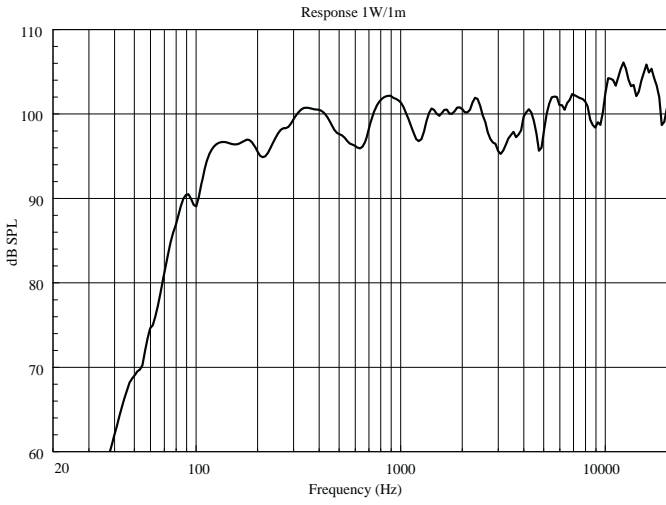

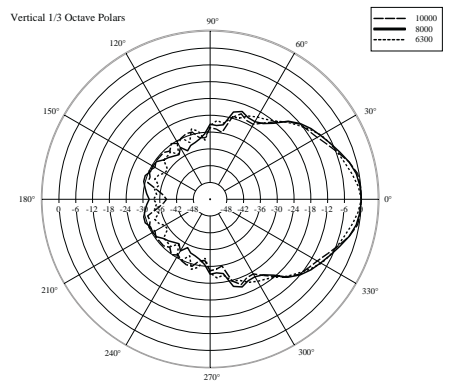
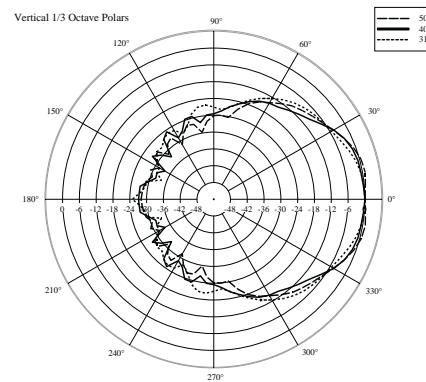
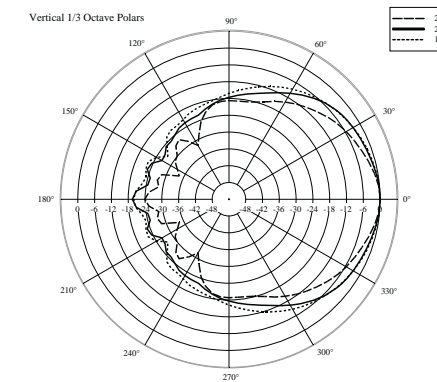
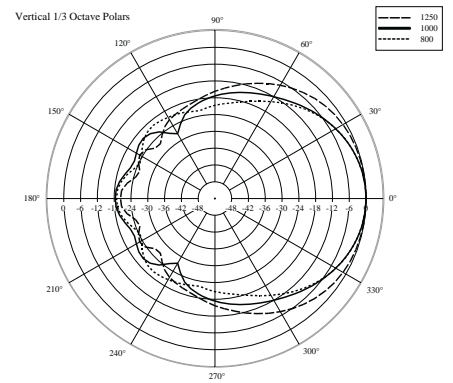
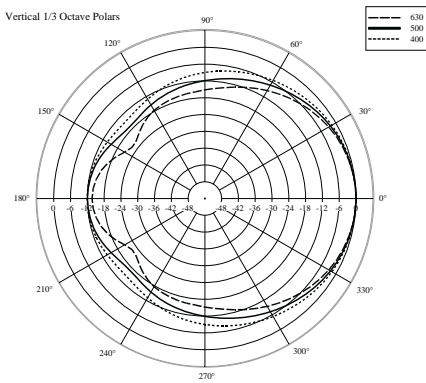
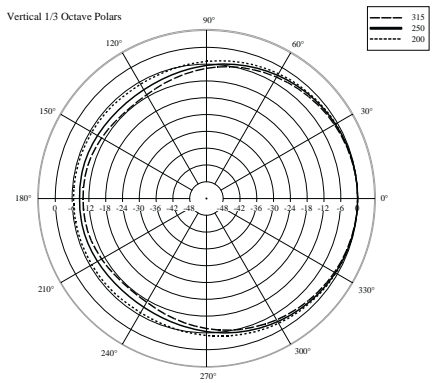
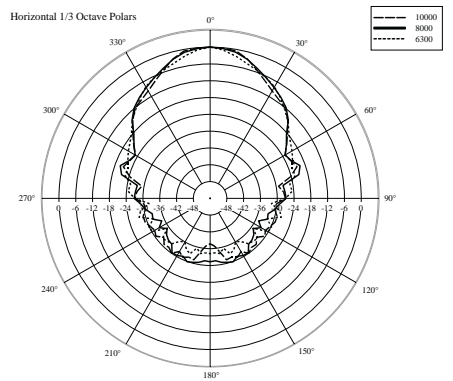
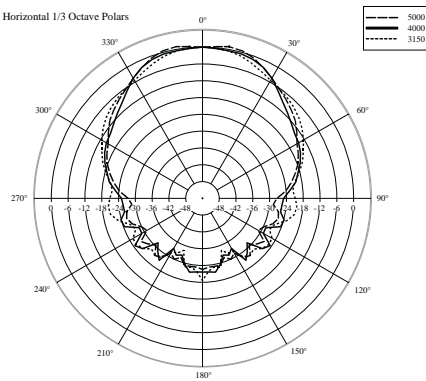
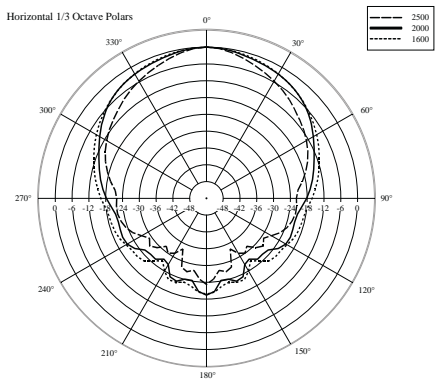
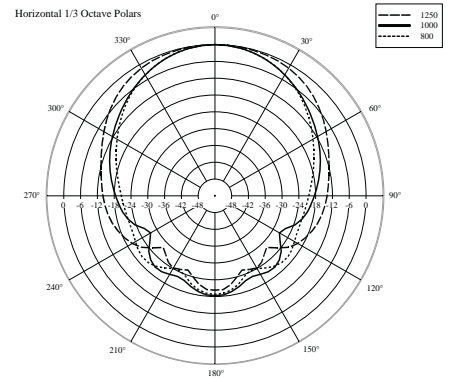
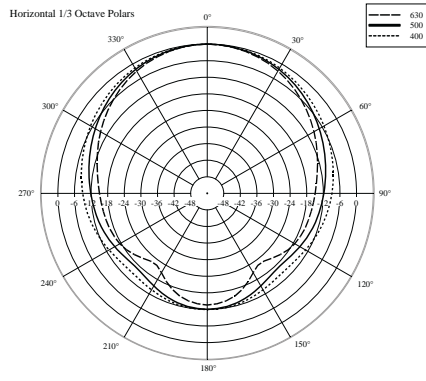
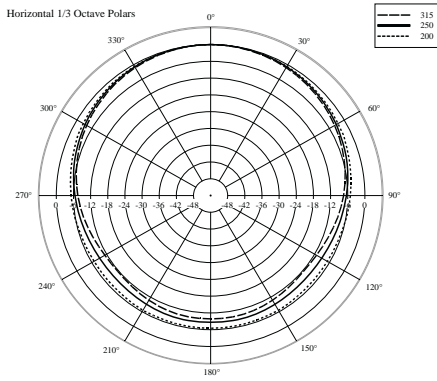

ACCESSORIES



AC P15 A-BR CLUSTER BRACK.- P6215/P3115

PART NUMBER **13360094**
EAN: 8024530006105
