

MX 3500/6

AMPLIFIED MASTER UNIT

DESCRIPTION

MX 3500 is the master unit of the Voice Alarm system DXT 3000, dedicated to small and medium size applications where an EN 54-16 certified system is required. It is equipped with powerful and exceptionally reliable Class D power amplifiers, able to provide up to 500 W of total power. Depending on the model, it is able to serve up to 6 independent zones. Moreover, the spare power amplifier facility is also available. The internal power supply is certified EN 54-4, and the back-up batteries can be host inside the cabinet, making the system a complete and extremely compact solution. Moreover, the on-board DSP platform allows optimizing environmental equalization, maximizing voice intelligibility and background music performance. The system can be completed with emergency microphone consoles BM 3804, BM 3804FM and ME 3801, and the buttons extensions BE 3806, allowing to add live announcements functionality.

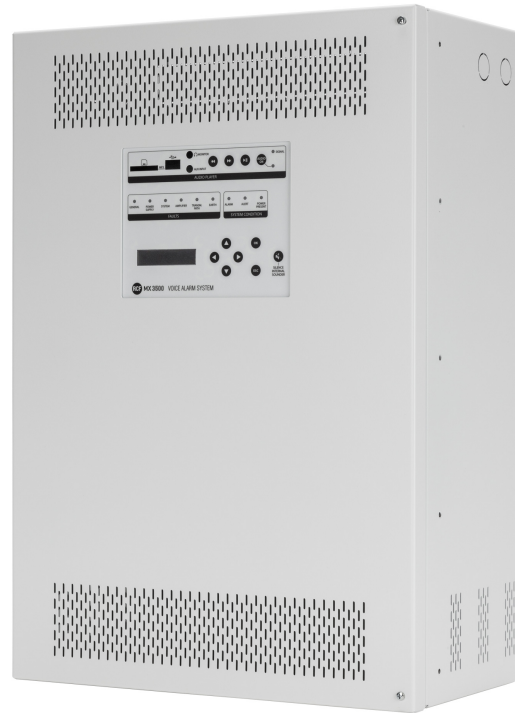

FEATURES

- 500 W total power
- Up to 6 zones controlled
- DSP platform on-board
- Certified EN 54-16 and EN 54-4
- Emergency messages on monitored SD card
- Spare power amplifier facility
- Integrated audio source on front panel
- Wall mount or rack mount installation

TECHNICAL SPECIFICATIONS

System specifications

Number of zones managed:	6
Built-in power amplifier:	Yes
Spare amplifier automatic change-over:	Yes
Max number of consoles:	4
Number of console buses:	1
Number of simultaneous emergency audio channels:	1
Max number of units connectable:	8
Communication bus:	Serial
Connection Cables:	J-Type fire-rated
Integrated pre-recorded emergency messages:	Yes

Amplifier specifications

Amplifier Class:	D+
Number of channels:	6
Power output (@ 100 V):	500 W RMS
A/B speakers line:	Yes
Frequency Response (-3dB):	80 Hz ÷ 16 kHz
Signal/noise rate ("A" weighted)	>80 dB
Distortion (THD+N) @ 1 kHz nominal power:	<0.3 %

Input section

Total number of inputs:	3
Balanced:	3
Mono:	3
Line inputs:	2
Line connectors:	Euroblock, JACK
VOX:	Yes
Paging inputs:	1
Paging connectors:	Euroblock
Paging command:	Serial
Paging emergency:	Yes
General Purpose Inputs (GPI):	6
Monitored GPI:	6
Photo-coupled GPI:	6

Output section

Signal output number:	1
Signal output connectors:	JACK
Power output lines:	6
Power output connectors:	Euroblock
General Purpose Outputs (GPO):	6

Processing

DSP:	Yes
Tone controls:	Yes
High-pass filter:	20 Hz ÷ 500 Hz



Controls	Configuration:	DIP switch, Front panel
	Chime tone:	Yes
Protections	Cooling:	Convection
	Short circuit:	Yes
	Thermal:	Yes
	DC:	Yes
	Fuses:	Yes
	VHF (Very High Frequencies):	Yes
Audio sources	USB pen drives:	Yes
	SD card:	Yes
Power requirement	Operating voltage:	220-240/115 V- 50/60Hz
	Voltage selection:	Internal
	DC power:	Yes
	DC power value:	48 V
	Power consumption:	700 W
Standard compliance	IP protection grade:	IP 30
	EN54-16 certified:	Yes
	EN54-4 certified:	Yes
	CE compliance:	Yes
	CPR number:	0068-CPR-007/2015
Physical specifications	Cabinet/Case Material:	Metal
	Color:	White
	Rack mounting:	19", 14U
Size	Height:	620 mm / 24.41 inches
	Width:	430 mm / 16.93 inches
	Depth:	230 mm / 9.06 inches
	Weight:	22 kg / 48.5 lbs
Shipping informations	Package Height:	340 mm / 13.39 inches
	Package Width:	680 mm / 26.77 inches
	Package Depth:	500 mm / 19.69 inches
	Package Weight:	25.8 kg / 56.88 lbs

PART NUMBER

- **12100011**
MX 3500/6

EAN 8024530014711

DRAWINGS

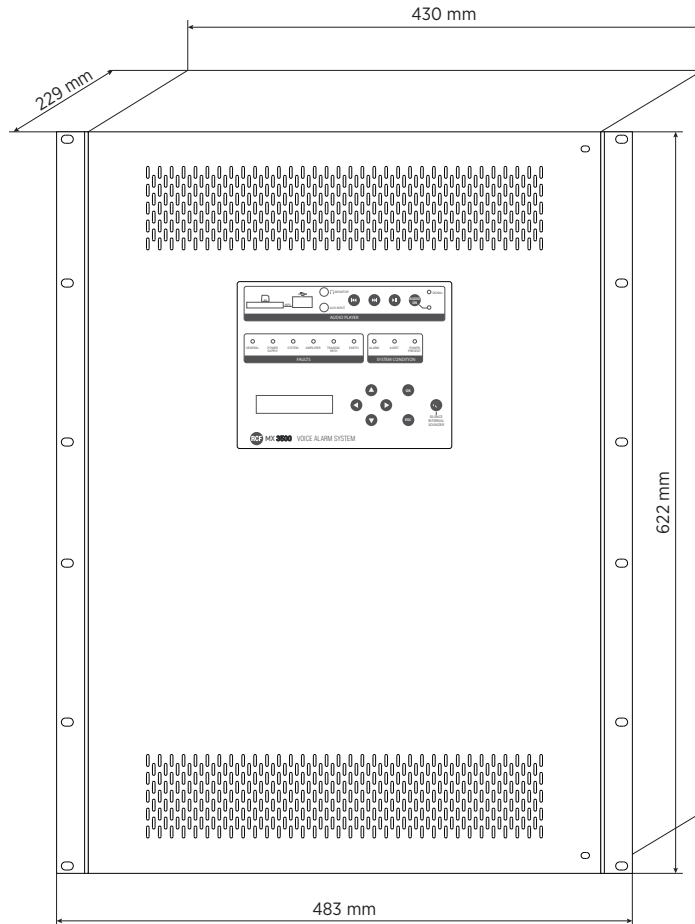

PANELS

Front panel

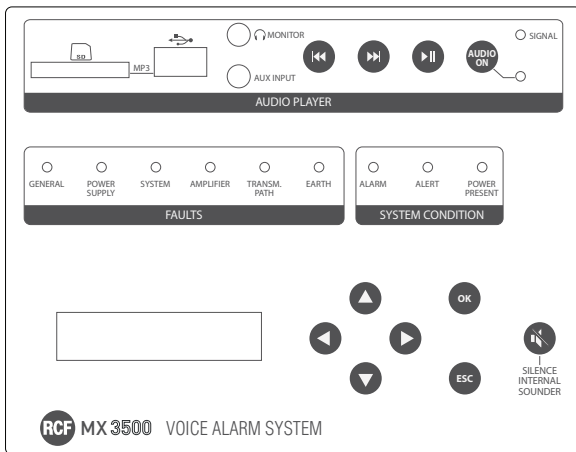

Internal connections

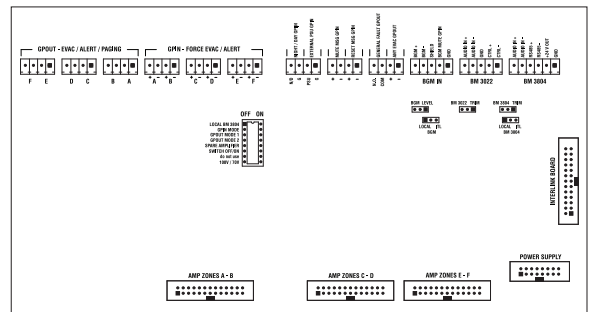

ACCESSORIES

BATT 18AH 2X PAIR OF BATTERIES 12V 18AH EVAC
SYS

PART NUMBER **13360317**
EAN: 8024530015923



BE 3806 ADDITIONAL KEYBOARD

PART NUMBER **14380036**
EAN: 8024530012120



BM 3022 PREAMPLIFIED MIC CONSOLE

PART NUMBER **14322013**
EAN: 8024530007034



BM 3804 EMERGENCY MIC CONSOLE

PART NUMBER **14380028**
EAN: 8024530012137



BM 3804FM FIREMEN EMERGENCY MIC CONSOLE

PART NUMBER **14380037**
EAN: 8024530012885



CJ 428CAT CABLE FTP 4x2x22 AWG CAT 5E FR
(PH120)

PART NUMBER **12399047**
EAN: 8024530016449



EOL 3-9 END OF LINE DXT3000 - DXT9000

PART NUMBER **17170176**
EAN: 8024530011864

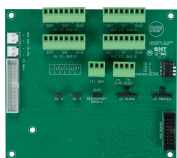

IE 3008 INTERLINK BOARD DXT 3000

PART NUMBER **12399015**
EAN: 8024530015152

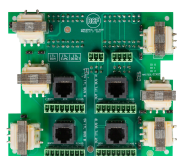

IT 3010 TRANSFORMERS BOARD DXT 3000

PART NUMBER **12399049**
EAN: 8024530016388



ME 3801 EMERGENCY MICROPHONE

PART NUMBER **14322030**
EAN: 8024530015732

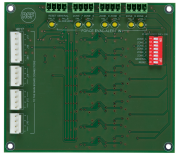

MG 3006 MONITORED GPI BOARD

PART NUMBER **13360344**
EAN: 8024530013356

A&E SPECIFICATIONS

The product shall be the master unit of the voice alarm system, dedicated to small and medium size applications where an EN 54-16 certified system is required.

It shall be equipped with powerful and exceptionally reliable 'Class D' power amplifiers, able to provide a total power up to 500 W.

Amplifier outputs shall be 100 V / 70 V (for constant voltage speaker lines).

Each zone shall have two outputs to get redundant lines.

It shall be able to serve up to 6 independent zones. Moreover, the last internal amplifier can be alternatively used as spare (with automatic change-over).

The internal power supply shall be EN 54-4 certified and the backup batteries shall be hosted inside the cabinet, making the system a complete and extremely compact solution.

A on-board DSP allows to optimize the equalization and get the best voice intelligibility and background music performance.

The system can be completed with emergency microphone consoles, allowing to add live announcements functionality.

A simple MP3 player shall be present on its front panel, having an additional aux input for external audio sources.

The master unit shall have an internal slot for an optional 'interlink' board for linking up to 8 master units one another.
