

USER MANUAL

MU 9186 **MU 9186R**

- DXT 9000 – EVACUATION / PAGING AUDIO SYSTEM
- MU 9186 – MAIN UNIT
- MU 9186R – MAIN UNIT WITH ROUTER





4	SAFETY PRECAUTIONS
5	NOTES ABOUT AUDIO SIGNAL CABLES
6	DXT 9000 SYSTEM DESCRIPTION
10	MU 9186 / MU 9186R MAIN UNIT DESCRIPTION
11	19" RACK INSTALLATION
12	FRONT PANEL
16	REAR PANEL
21	MAIN MENU AND ACCESS LEVELS
23	EVENT MENU
23	DISABLE-SURV MENU
25	AUDIO SET MENU
25	- AUDIO SET > INPUTS SUBMENU
30	- AUDIO SET > OUTPUTS SUBMENU
31	- AUDIO SET > MP3 & MONIT SUBMENU
32	- AUDIO SET > ROUTN PROG SUBMENU
33	- AUDIO SET > RTNG & PRST SUBMENU
34	- AUDIO SET > ZONE VOL SUBMENU
34	INFO MENU
35	SYS LOG MENU
36	SYS CONFIG MENU
36	- SYS CONFIG > ZONE-GRP SUBMENU
37	- SYS CONFIG > PAG CONS SUBMENU
40	- SYS CONFIG > GPI-VOX SUBMENU
42	- SYS CONFIG > GPO SUBMENU
43	- SYS CONFIG > REM-N&D SUBMENU
44	- SYS CONFIG > SETTINGS SUBMENU
45	DISPLAY LISTS
46	DISPLAY TEXT MESSAGES
48	MU 9186 – JUMPER SETTINGS
49	CONNECTION EXAMPLE
50	MAINTENANCE NOTES
51	WIRING
52	GUIDANCE ON THE MEASUREMENT OF THE SPEAKER LINE IMPEDANCE
56	SPECIFICATIONS
57	APPENDIX

**IMPORTANT**

Before connecting and using this product, please read this instruction manual carefully and keep it on hand for future reference.

The manual is to be considered an integral part of this product and must accompany it when it changes ownership as a reference for correct installation and use as well as for the safety precautions. RCF S.p.A. will not assume any responsibility for the incorrect installation and / or use of this product.

WARNING: To prevent the risk of fire or electric shock, never expose this product to rain or humidity. This device is intended for indoor use only.

SAFETY PRECAUTIONS

1. All the precautions, in particular the safety ones, must be read with special attention, as they provide important information.

2.1 PRIMARY POWER SUPPLY FROM MAINS

- The mains voltage is sufficiently high to involve a risk of electrocution: never install or connect this product when its power cord is plugged in.
- Before powering up, make sure that all the connections have been made correctly and the voltage of your mains corresponds to the voltage shown on the rating plate on the unit, if not, please contact your RCF dealer.
- This apparatus can be connected to either TT or TN earthing arrangements only.
- The metallic parts of the unit are earthed by means of the power cord. An apparatus with CLASS I construction shall be connected to a mains socket outlet with a protective earthing connection.
- This apparatus shall be connected to a facility equipped device to protect against earth faults, appropriately sized for the type and power of the installed line (RCD).
- Protect the power cord from damage. Make sure it is positioned in a way that it cannot be stepped on or crushed by objects.
- To prevent the risk of electric shock, never open this product: there are no parts inside that the user needs to access.
- The mains plug is used to disconnect the device and it shall remain readily operable.

2.2 SECONDARY (/ EMERGENCY) POWER SUPPLY THROUGH BATTERIES

- The apparatus operating voltage is 48 V dc (therefore, it is necessary to connect in series several batteries having a lower nominal voltage, example: 4 x 12 V, 2 x 24 V).
- Always use rechargeable batteries, which need to be chosen according to the maximum possible load.
- Verify the polarity of batteries is correct.
- Do NOT short-circuit batteries (i.e. connecting the 2 opposite poles together with metallic wires).
- The 48 V dc plug is used to disconnect the device and it shall remain readily operable.
- The 48 V dc power supply does not go beyond the fact that there are dangerous voltages inside the unit.
- Throw empty batteries away according to your country laws about ecology and environment protection.

3. Make sure that no objects or liquids can get into this product, as this may cause a short circuit. This apparatus shall not be exposed to dripping or splashing. No objects filled with liquid (such as vases) and no naked sources (such as lighted candles) shall be placed on this apparatus.

4. Never attempt to carry out any operations, modifications or repairs that are not expressly described in this manual.

Contact your authorized service centre or qualified personnel should any of the following occur:

- The product does not function (or functions in an anomalous way).
- The power cord has been damaged.
- Objects or liquids have got into the product.
- The product has been subject to a heavy impact.

5. If this product is not used for a long period, disconnect its power cord and batteries.

6. If this product begins emitting any strange smell or smoke, **switch it off immediately and disconnect its power cord and batteries.**

IMPORTANT**WARNING**

7. The terminals marked with the symbol  are HAZARDOUS LIVE and their connection is to be made by an INSTRUCTED PERSON or the use of ready-made cables is required.

8. Do not connect this product to any equipment or accessories not foreseen.
For suspended installation, only use the dedicated anchoring points and do not try to hang this product by using elements that are unsuitable or not specific for this purpose.
Also check the suitability of the support surface to which the product is anchored (wall, ceiling, structure, etc.), and the components used for attachment (screw anchors, screws, brackets not supplied by RCF etc.), which must guarantee the security of the system / installation over time, also considering, for example, the mechanical vibrations normally generated by transducers.
To prevent the risk of falling equipment, do not stack multiple units of this product unless this possibility is specified in this user manual.

9. RCF S.p.A. strongly recommends this product is only installed by professional qualified installers (or specialised firms) who can ensure correct installation and certify it according to the regulations in force.

The entire audio system must comply with the current standards and regulations regarding electrical systems.

10. Supports and trolleys

The equipment should be only used on trolleys or supports, where necessary, that are recommended by the manufacturer. The equipment / support / trolley assembly must be moved with extreme caution. Sudden stops, excessive pushing force and uneven floors may cause the assembly to overturn.

11. Mechanical and electrical factors need to be considered when installing a professional audio system (in addition to those which are strictly acoustic, such as sound pressure, angles of coverage, frequency response, etc.).

12. Hearing loss

Exposure to high sound levels can cause permanent hearing loss. The acoustic pressure level that leads to hearing loss is different from person to person and depends on the duration of exposure. To prevent potentially dangerous exposure to high levels of acoustic pressure, anyone who is exposed to these levels should use adequate protection devices.

When a transducer capable of producing high sound levels is being used, it is therefore necessary to wear ear plugs or protective earphones.

See the technical specifications in loudspeaker instruction manuals to know their maximum sound pressure levels.

13. Do not obstruct the ventilation grilles of the unit. Situate this product far from any heat sources and always ensure adequate air circulation around the ventilation grilles.

14. Do not overload amplifiers. Check that amplifier outputs are not shorted.

15. Never force the control elements (keys, knobs, etc.).

16. Do not use solvents, alcohol, benzene or other volatile substances for cleaning the external parts of this product.
Use a dry cloth.



WARNING:

Any change made by unauthorized personnel to the product and / or the system (in which it is installed and configured, including rack cabinet and wiring) may invalidate the CE marking (certification EN54-16: 2008) and also the product warranty.

NOTES ABOUT AUDIO SIGNAL CABLES



To prevent the occurrence of noise on microphone / line signal cables, use screened cables only and avoid putting them close to:

- Equipment that produces high-intensity electromagnetic fields.
- Mains cables.
- Loudspeaker lines.

RCF S.P.A. THANKS YOU FOR PURCHASING THIS PRODUCT, WHICH HAS BEEN MADE TO GUARANTEE RELIABILITY AND HIGH PERFORMANCE.

DXT 9000 SYSTEM DESCRIPTION



DXT 9000 is a monitored digital paging / evacuation system in compliance with EN 54-16 and ISO 7240-19 that allows a completely scalable and versatile range of configurations and solutions.

It features a double-ring topology approach: a first simple ring for the small and medium size systems and a second larger ring supported by a main unit with router (MU 9186R) for large and extra-large applications, always plug & play and easy-configurable.

For instance, a small system can be designed by using only one MX 9502 / MX 9504 main unit, which already includes all the necessary controls and two 250 W (MX 9502) / four 125 W (MX 9504) class D power amplifiers (having 100 V / 70 V constant voltage loudspeaker lines).

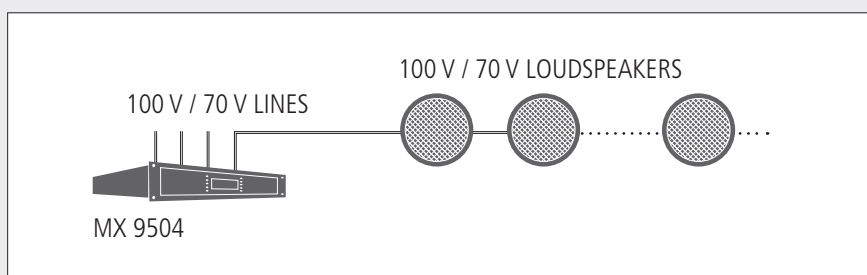

A system that requires a higher output power or a larger number of zones can be obtained by adding one or more system amplifiers model UP 9501 (1 x 500 W), UP 9502 (2 x 250 W) or UP 9504 (4 x 125 W) to the MX 9502 / MX 9504, connected through the dedicated RCF FLEXCOM data-link port.

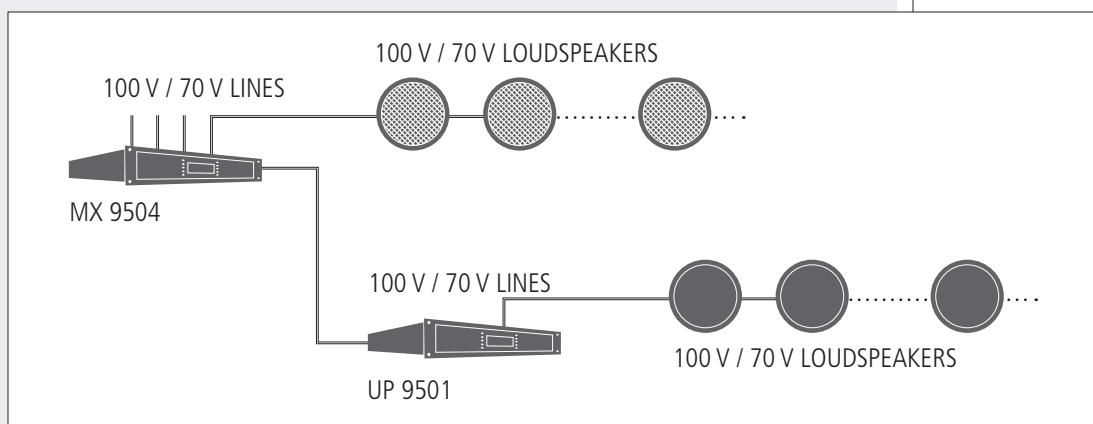

MU 9186 is another main unit model similar to MX 9502 / MX 9504, but without internal power amplifiers.

Since data wiring may have critical connections, for instance due to cable type and length, RCF FLEXCOM bus can adapt the data communication speed to the wiring characteristics and available data band.

Only a few devices are necessary to design the simplest and the most complex projects, centralized or distributed: no matter if a supermarket or a theatre, an airport or a shopping centre, a fast-food or an underground, a school or a hospital.

Diagnostic functions and fault reporting meet all evacuation system requirements.

Wiring is limited to a twin pair J-type fire-rated cable for most of connections and to a four-pair J-type fire-rated cable to link paging microphones.

The system configuration can be edited on the main unit front panel (for small systems), but it can also be made through a local or remote PC, by using a dedicated graphic user interface software.

The dual power supply allows both AC and DC operation.

The 'RCF D+ Class' power amplifier technology and recover-fall-back built-in facility make the DXT 9000 a highly secure, reliable and safe system.

Each DXT 9000 unit is equipped with an RS 485 serial port to be used for the dedicated system programmable remote controls. Noise detection devices work on RS 485 port as well.

Two pre-recorded messages can be simultaneously played and sent to the DXT 9000 network from main units, which can store both emergency messages (to a checked dedicated memory) and routine messages (on separated SD cards). Another SD/USB support is used as MP3 player (to play background music).

The Ethernet port (on main units) allows to get the complete remote control of the whole system.

DXT 9000 devices have programmable logic inputs and outputs, checked by the system itself or by the connected security/emergency devices, such as fire alarm systems.

Each component has its own digital address.

DXT 9000 includes high quality digital components already in use for RCF professional audio systems, obtaining high performances and qualifying the DXT 9000 system for installations in places that require a very good sound reproduction, such as theatres and auditoriums.

DXT 9000 SYSTEM COMPONENTS

- MX 9502 Main unit including two 250 W class D amplifiers inside
- MX 9504 Main unit including four 125 W class D amplifiers inside
- MU 9186 Main unit (no power amplifiers inside)
- MU 9186R Main unit with router (no power amplifiers inside)
- UP 9501 Unit with a single 500 W class D amplifier
- UP 9502 Unit with two 250 W class D amplifiers
- UP 9504 Unit with four 125 W class D amplifiers
- BM 9804 Paging microphone with zone selection
- BM 9802 Paging microphone with zone selection through numeric keyboard
- BE 9808 Additional 8-zone keyboard for paging microphones
- IN 9000 Integrity network emergency console

DXT 9000 SYSTEMS WITH AUDIO NETWORK

DXT 9000 systems with network can have up to eight subsystems, each with its own MU 9186R master unit (special MU 9186 with 'Dante' board inside to send and receive audio signals on Ethernet) and its UP 950x amplifiers.

Subsystems are independent and need to be configured individually, but they can communicate with one another to get 'global' functions (common for the network) through network switches (i.e. Cisco IE 3000, not included).

Please refer to the DXT 9000 PC software manual.

EXAMPLE: SYSTEM WITH MX 9504 MAIN UNIT

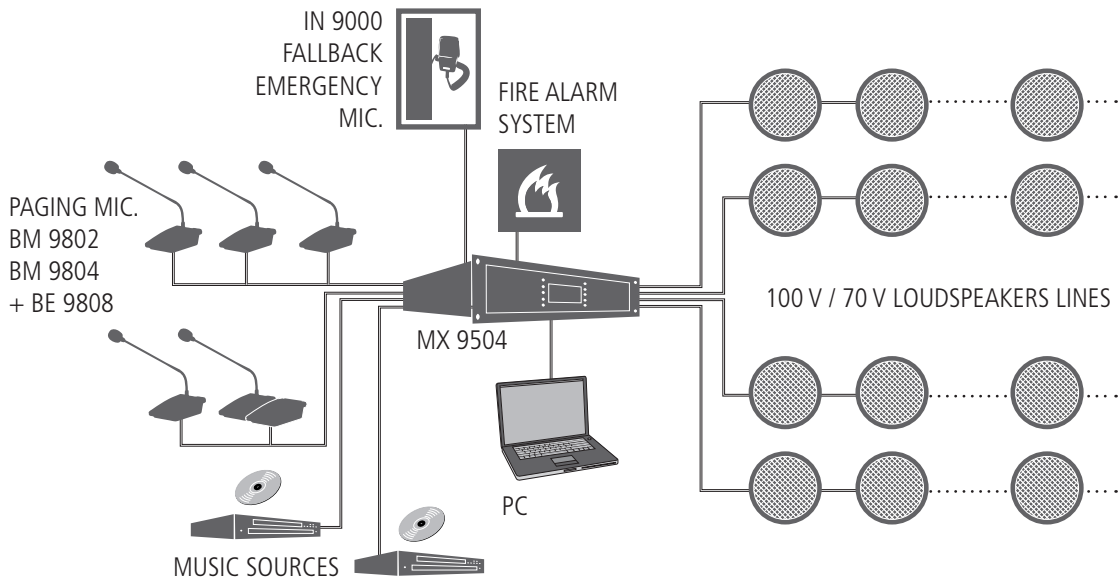

EXAMPLE: SYSTEM WITH MU 9186 MAIN UNIT

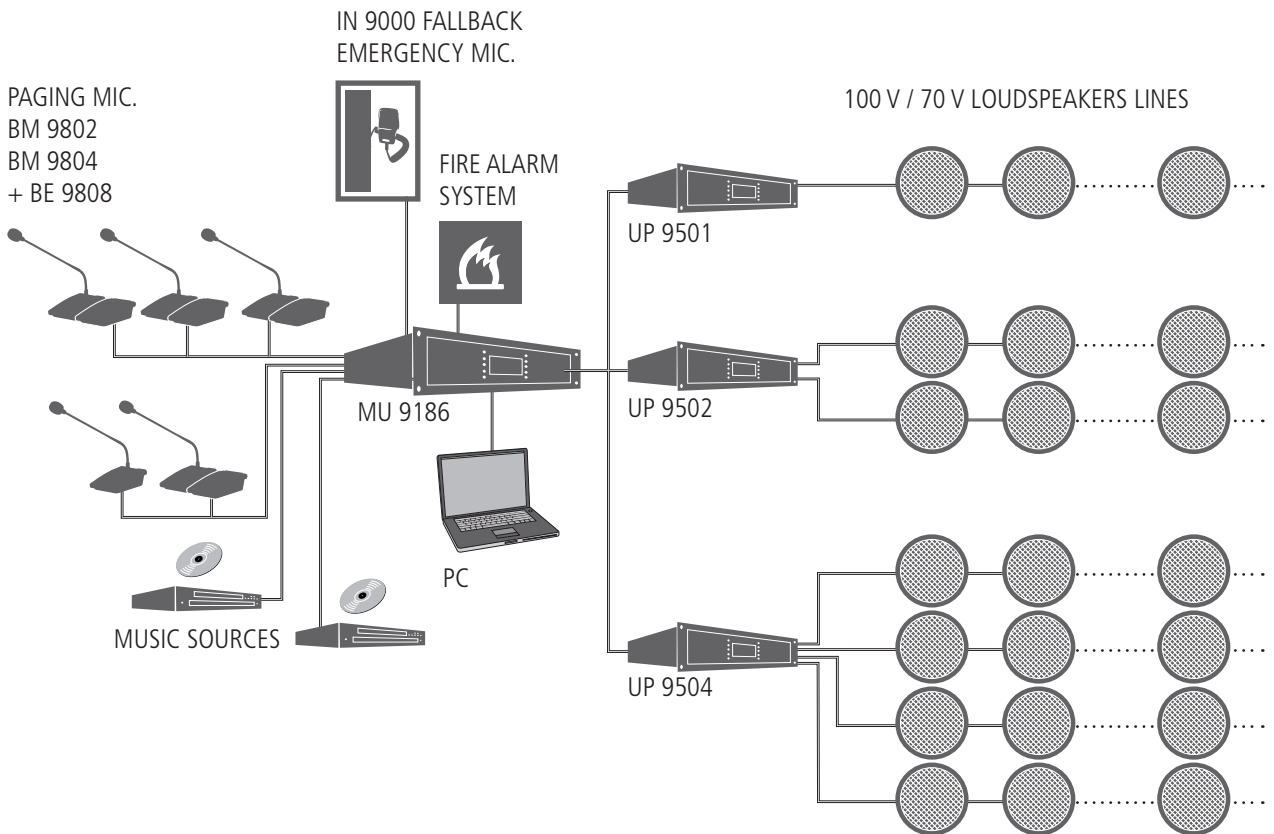

EXAMPLE: SYSTEM WITH NETWORK

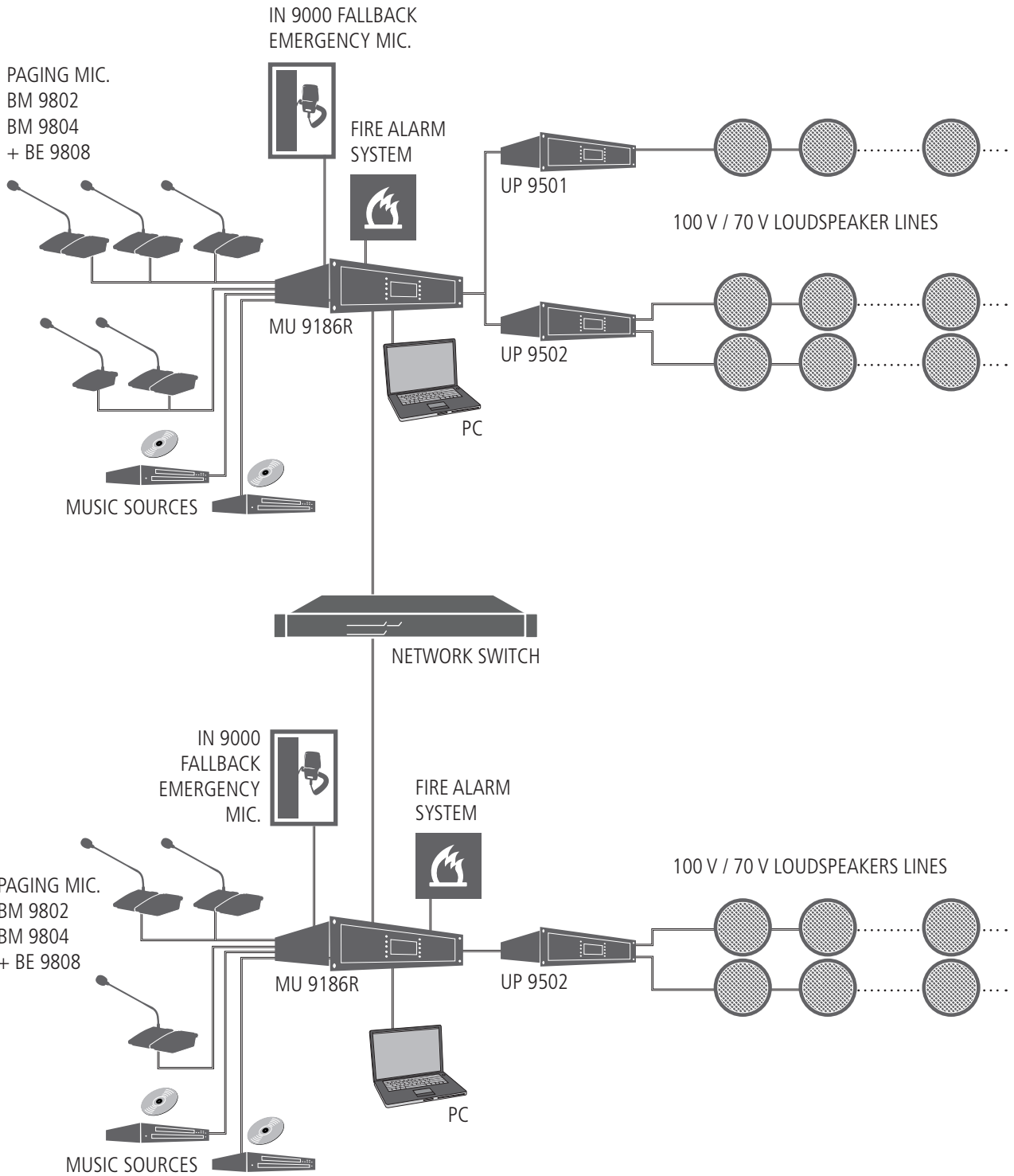

MU 9186 / MU 9186R MAIN UNIT DESCRIPTION



MU 9186 is a main unit with audio inputs and outputs, a pre-recorded message player, control / surveillance functions, MP3 player.

When used with 100 V / 70 V line loudspeakers, the MU 9186 needs to be combined with UP 9500 series amplifiers.

The MU 9186 main unit can drive several UP 9500 series amplifiers.
A UP 9501 amplifier can be set as 'spare' that automatically replaces a faulty one.

MAIN FEATURES

- Configurable digital matrix.
- Fully monitored as according to the EN 54-16 and ISO 7240-19 standards.
- The zone configuration is virtual and can be set after the system installation.
- Two bus inputs for paging microphones.
- FALL-BACK input to connect an independent dedicated EVAC paging microphone.
- Digital signal processor on both inputs and outputs. A compressor can be inserted on the AUX and MAIN inputs.
- Evacuation messages (with priority) are stored to a checked and protected internal memory. Two messages (for evacuation, routine communications or advertisements) can be played simultaneously (to different zones).
- SD slot for cards with routine messages that can be triggered from GPI or the internal timer.
- MP3 player (with USB port and SD card slot) for background music.
- The BGM1 analogue audio input can be alternatively replaced by the MP3 player and the PAGING IN 2 input by the AUX INPUT. This can be made by using software presets.
- AUX and MONITOR audio outputs.
- Graphic user interface to set all system parameters directly from a PC through USB port.
- Front panel control with LCD.
- RCF-FLEXCOM technology digital Audio Bus to connect amplifiers (UP 9501, UP 9502, UP 9504).
- 12 GPI logic inputs (8 monitored and 4 optical) and 8 GPO logic outputs (relays).
- RS 485 serial port (screw terminals) for interfacing and monitoring.
- ETHERNET port (RJ 45 connector) for local area network (LAN) applications, local and remote system configuration.
- Optional programme selector and level remote control.
- AC and DC power supply.
- MU 9186R model has inside a 'Dante' network.

BLOCK DIAGRAM

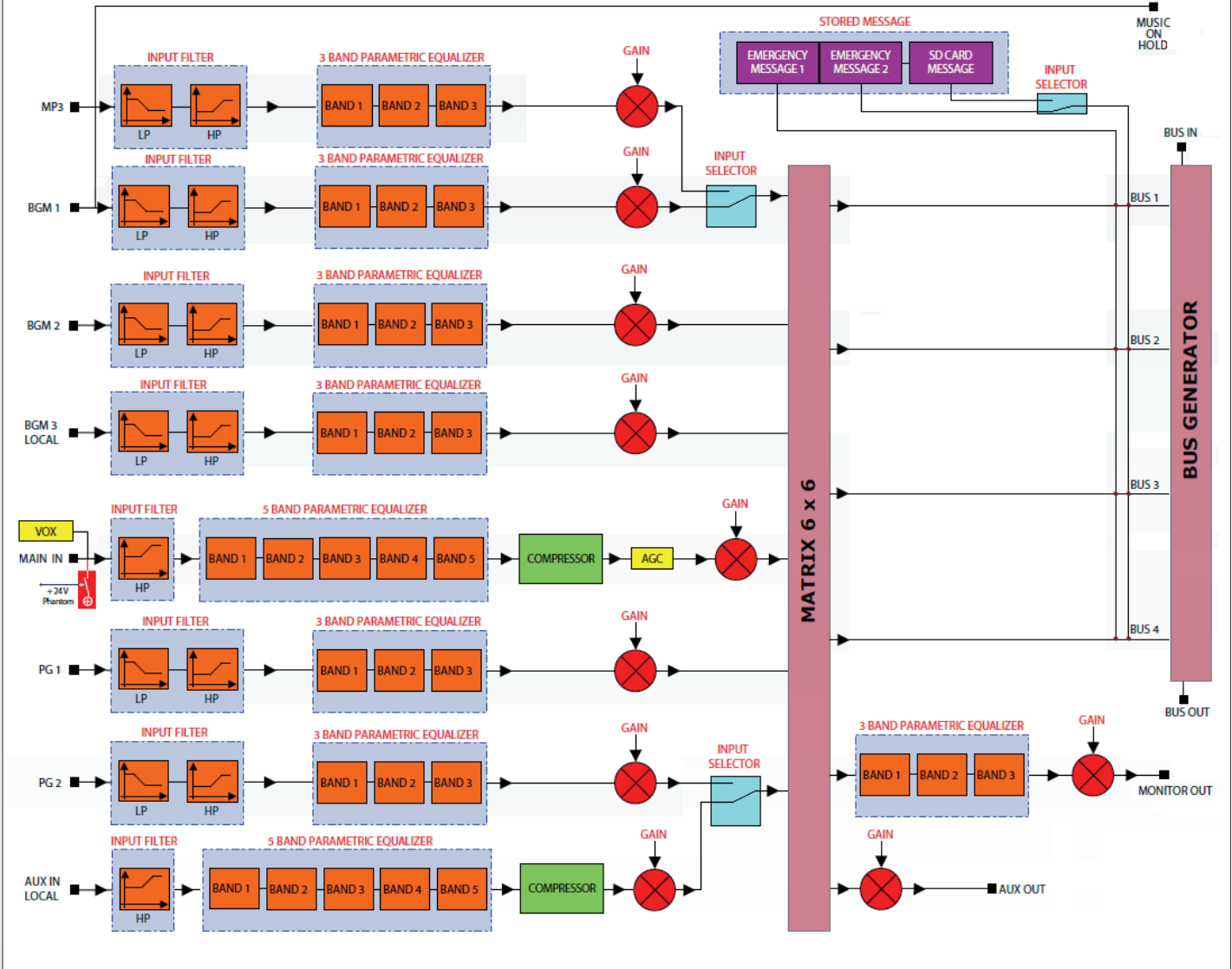

19" RACK INSTALLATION



Fix the MU 9186 main unit to the front side of a 19" rack cabinet through 4 screws.

Rack cabinets shall have:

- At least an IP 30 rating.
- A door with glass (or a thin metal mesh), through which the warning and emergency light indications are clearly visible (according to regulations).

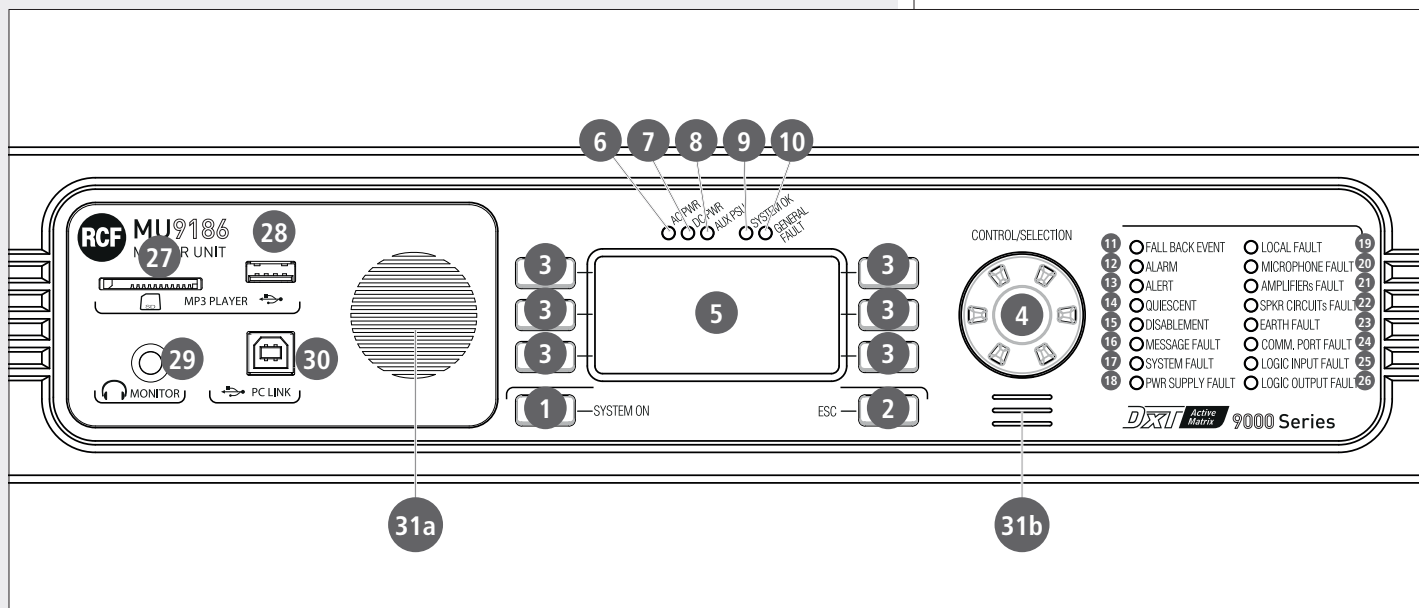

1 SYSTEM ON: button: press and hold to turn the MU 9186 main unit on (when off). This button also works as fault acknowledge: press it to remove the displayed fault indication.

THE SYSTEM ON BUTTON DOES NOT TURN THE MAIN UNIT OFF. TO SWITCH THE MAIN UNIT OFF, MAKE SURE THE 48 V DC POWER SUPPLY (BATTERIES) IS NOT PRESENT AND USE EITHER THE PROPER SOFTWARE FUNCTION OR THE MAIN POWER **52** SWITCH ON THE REAR PANEL.

2 ESC ('Escape') button: press to quit the displayed menu.

3 Six buttons to select the respective functions shown on the display.

4 CONTROL / SELECTION: rotary encoder and push-button to select. Turn the encoder clockwise to scroll the menu downwards or increase the selected parameter value. Turn it counterclockwise to scroll the menu upwards or decrease the selected parameter value. Press to select.

5 Display (LCD)



No.	SILK SCREEN	COLOUR	INDICATION (WHEN LIT)	FURTHER INFORMATION
6	AC PWR	Green	The mains power (AC) is present and the respective fuse is intact.	If the LED is off, the mains power is not available (or out of range).
7	DC PWR	Green	48 V dc power supply is present and the respective fuse is intact.	If the LED is off, 48 V dc is not available (or out of range).
8	AUX PSU	Green	The main unit is turned on and its stand-by power supply unit operates properly.	
9	SYSTEM OK	Green	No detected faults: the entire system is operating properly.	The LED is lit when no faults are detected on any system device.
10	GENERAL FAULT	Yellow	One or more faults have been detected, including problems on power supply, so it can be lit even if the AC PWR 6 and DC PWR 7 green LEDs are off. The LED gets lit even in case of failure of any peripheral unit.	If a logic input (GPI) is set to obtain a fault remote indication of an external device, a possible problem is indicated by the GENERAL FAULT LED.
11	FALL BACK EVENT	Red	An emergency announcement (with highest priority) is in progress through the FALL BACK INPUT 32.	
12	ALARM	Red	The evacuation message is currently played. This LED also indicates the play of a message from a microphone or an external source activated as EMERGENCY (GPI set to EMERG).	
13	ALERT	Yellow	The alert message is currently played. This LED also indicates the play of a message from a microphone or an external source activated as ALERT (GPI set to ALERT).	
14	QUIESCENT	Green	The device is switched on but not playing any audio signal.	It simply indicates an idle state, as there is no audio signal.
15	DISABLEMENT	Yellow	One or more device inputs, outputs or peripherals are disabled.	This LED is lit only in case of one or more circuits and/or devices used for evacuation/emergency are disabled. In the case, for example, of a non-monitored paging microphone, its disabling will not make the LED get lit.
16	MESSAGE FAULT	Yellow	Main unit emergency message player fault.	Faulty memory or problems on the audio path (the internal message player is not properly linked to the system audio outputs).

No.	SILK SCREEN	COLOUR	INDICATION (WHEN LIT)	FURTHER INFORMATION
17	SYSTEM FAULT	Yellow	Internal microprocessor reset.	After rebooting, the LED will be off, but the reset event will remain in the SYSTEM / FAULT LOG.
18	PWR SUPPLY FAULT	Yellow	Power supply fault (internal power supply, internal boards or external power supply).	A logic input (GPI) needs to be linked to the logic output of the external power supply unit and set to EXTERNAL EVENT FAULT. A possible external power supply unit fault is displayed as EXTERNAL PSU FAULT.
19	LOCAL FAULT	Yellow	Main unit local fault. This LED gets lit even in case of main power fault. This LED is lit in the faulty device only. For instance, if a SLAVE unit is faulty and the MASTER unit is properly operating, this LED is lit on the SLAVE unit only, while the SYSTEM FAULT 17 LED is lit on both MASTER and SLAVE units.	If a logic input (GPI) is set to signal a possible fault of an external system, this will be indicated by the LOCAL FAULT LED (only in the unit where the logic input has been activated).
20	MICROPHONE FAULT	Yellow	An emergency paging microphone (among those connected to FALL BACK 32 or PAGING 1 41 / PAGING 2 42 inputs, if set to EMERGENCY in the software) is faulty.	On SLAVE units, it only indicates of the paging microphones connected to the FALL BACK input.
21	AMPLIFIERs FAULT	Yellow	One or more amplifiers are faulty.	
22	SPKR CIRCUITs FAULT	Yellow	One or more loudspeaker lines are faulty.	
23	EARTH FAULT	Yellow	Loudspeaker line earth leakage.	Earth leakage < 50 kΩ

No.	SILK SCREEN	COLOUR	INDICATION (WHEN LIT)	FURTHER INFORMATION
24	COMM. PORT FAULT	Yellow	Hardware / RS 485 serial port (for linking to a fire alarm system) fault.	This indication depends on either a broken / short-circuited cable or no data transmission (for example, due to a damaged serial port) or remote device unavailable.
25	LOGIC INPUT FAULT	Yellow	GPI fault. The LED gets lit when the logic input is monitored and its respective line is open or shorted.	A logic input (GPI) needs to be monitored when linked to a fire alarm system (to activate pre-recorded messages remotely).
26	LOGIC OUTPUT FAULT	Yellow	GPO fault. The LED gets lit when the logic output is monitored and its respective line is open or shorted.	A logic output (GPO) needs to be monitored when linked to a fire alarm system (for example, to signal an audio system fault to the fire alarm system).

27 MP3 player SD card slot.
SD cards must be max. 16 GB, formatted FAT32 and include MP3 files.

28 USB port (type A) for USB flash drives (MP3 player).

29 MONITOR: 6.3 mm jack input (TRS) for headphones.

30 PC LINK: USB port (type B) to connect a PC that can be used to configure and manage the system.

31a Internal loudspeaker (monitor).

31b Internal buzzer for fault alert (or evacuation message in progress).
It can be muted by pressing the SYSTEM ON **1** button.

MU 9186 – REAR PANEL

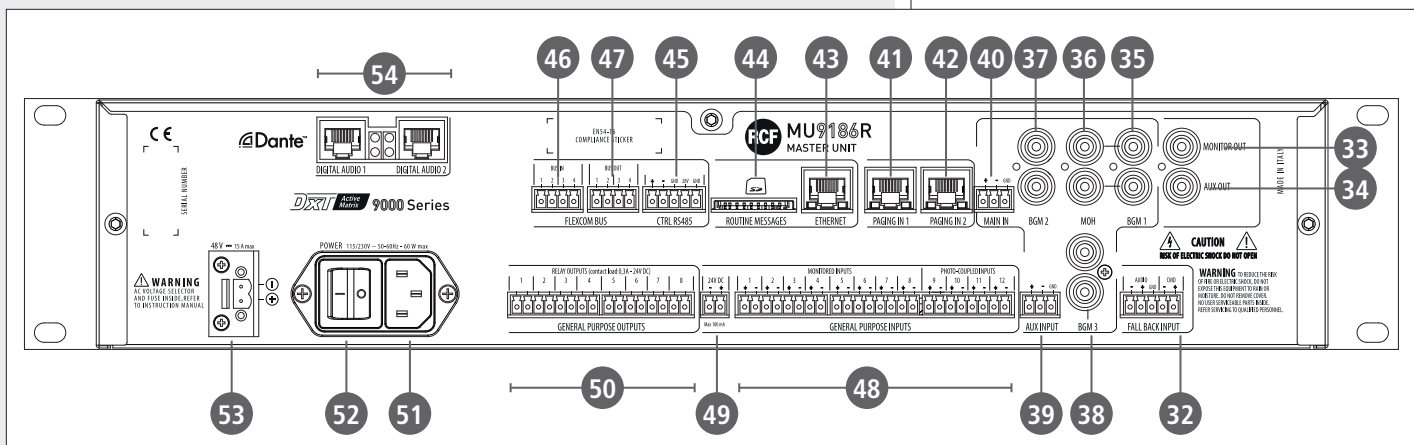

32 FALL BACK INPUT: monitored audio input (balanced, 'line' level, for removable connector) to be used for emergency announcements. This input can be used even in case of software crash.

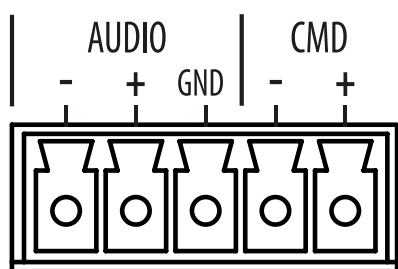

FALL BACK INPUT

AUDIO	-	Audio signal (cold)
	+	Audio signal (hot)
	GND	Audio signal ground
CMD	-	Activation and monitoring contacts of the FALL BACK audio input.
	+	

For monitoring purposes, the two CMD contacts should normally be powered by 24 V dc (voltage available from the 24 V DC **49** output). FALL BACK input state depends on presence and polarity of the voltage at the two CMD contacts.

STATE	Voltage at the CMD contacts	Description
COMMAND KO	No voltage	The FALL BACK INPUT is not connected
IDLE	24 V dc, direct polarity	The FALL BACK INPUT is connected, but inactive
ACTIVE	24 V dc, reverse polarity	The FALL BACK INPUT is activated

33 MONITOR OUT audio output (RCA connector).

34 AUX OUT audio output (RCA connector).

35 BGM 1 audio input (dual RCA connector) for a 'line' level signal (i.e. CD / MP3 player, tuner).

36 MOH ('Music On Hold'): parallel output of the **BGM 1 35** input that can be connected, for example, to a phone system to get the 'Music On Hold'.

37 BGM 2 audio input (dual RCA connector) for a 'line' level signal (i.e. CD / MP3 player, tuner).

38 BGM 3 audio input (dual RCA connector) for a 'line' level signal (i.e. CD / MP3 player, tuner).

MU 9186R (master unit with router): BGM 3 analogue input is disabled and replaced by the 'Dante' input channel.

THE TWO CHANNELS (LEFT / RIGHT) OF STEREO SIGNALS ON **BGM 1 35**, **BGM 2 36** AND **BGM 3 38** INPUTS ARE MIXED IN MONO INSIDE THE DEVICE. THE TWO CHANNELS (LEFT / RIGHT) OF THE SIGNAL ON **BGM 1 35** INPUT ARE DIRECTLY SENT TO THE **MOH 36** PARALLEL OUTPUT, WHICH IS STEREO.

39 AUX INPUT balanced audio input (removable connector).

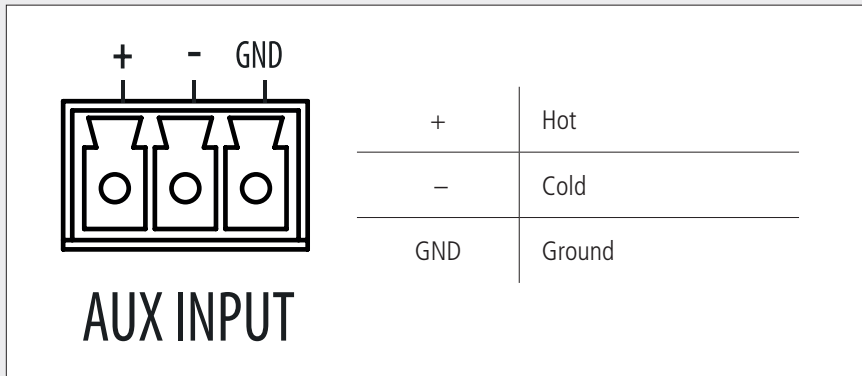

40 MAIN IN balanced audio input (removable connector).

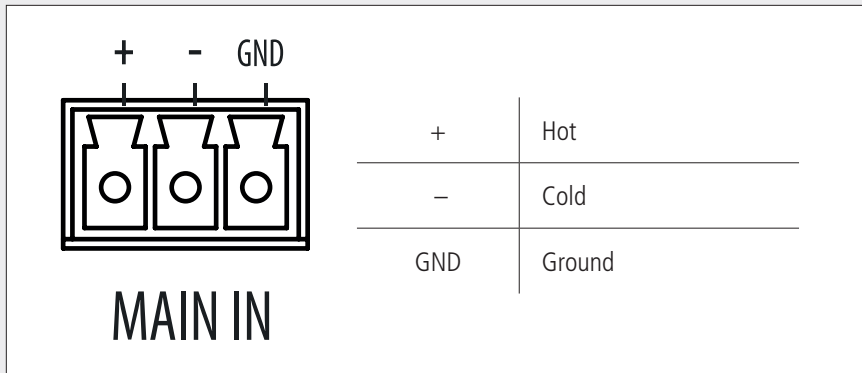

MAIN IN CAN HAVE THE 'VOX' FUNCTION ENABLED, WHICH AUTOMATICALLY DETECTS THE AUDIO SIGNAL PRESENCE WHEN ABOVE A PREDEFINED THRESHOLD.



41 PAGING IN 1 input (RJ 45 connector) to link paging microphones.

42 PAGING IN 2 input (RJ 45 connector) to link paging microphones.



PAGING 1 AND PAGING 2 INPUT PINS:

PIN		PIN	
1	Audio signal (+, hot)	5	Audio signal ground
2	Audio signal (-, cold)	6	Power supply + 28 V dc
3	Digital and power supply ground	7	RS 485 A (+)
4	Audio signal ground	8	RS 485 B (-)

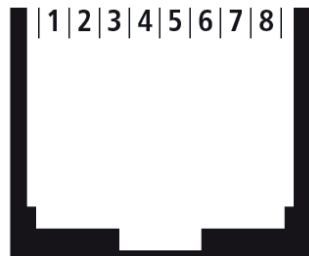

RJ 45 socket

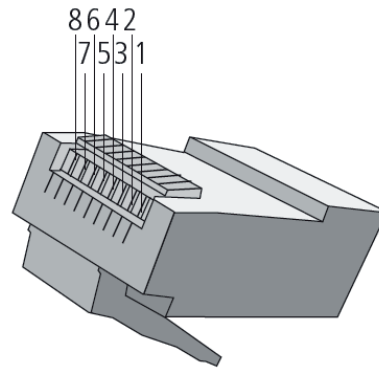

RJ 45 plug

43 ETHERNET port (RJ 45 socket)

44 ROUTINE MESSAGES: slot for SD cards including routine (non-emergency) message audio files.

45 CTRL RS485: RS 485 serial port (removable connector).

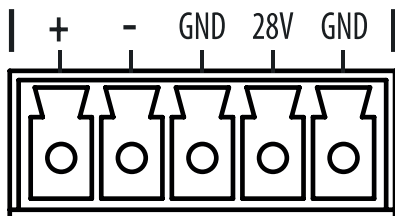

CTRL RS485

+	RS 485 A (non-inverting)
-	RS 485 B (inverting)
GND	RS 485 (reference ground)
28V	Power supply + 28 V dc
GND	Power supply ground

46 FLEXCOM BUS IN: data bus input (removable connector).

47 FLEXCOM BUS OUT: data bus output (removable connector).

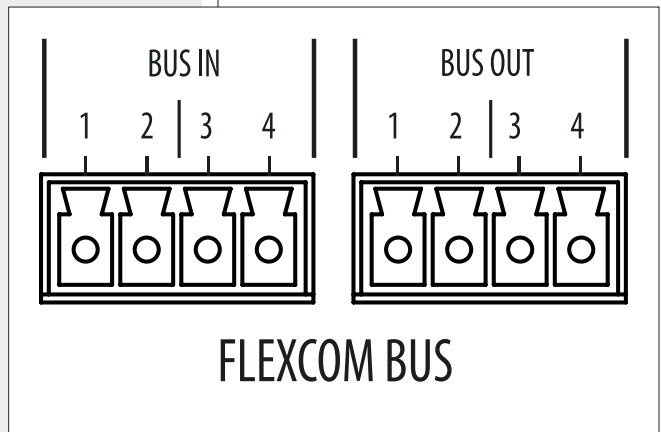

48 GENERAL PURPOSE INPUTS

12 logic inputs (removable connectors), of which the first 8 are monitored and the last 4 with opto-isolators.

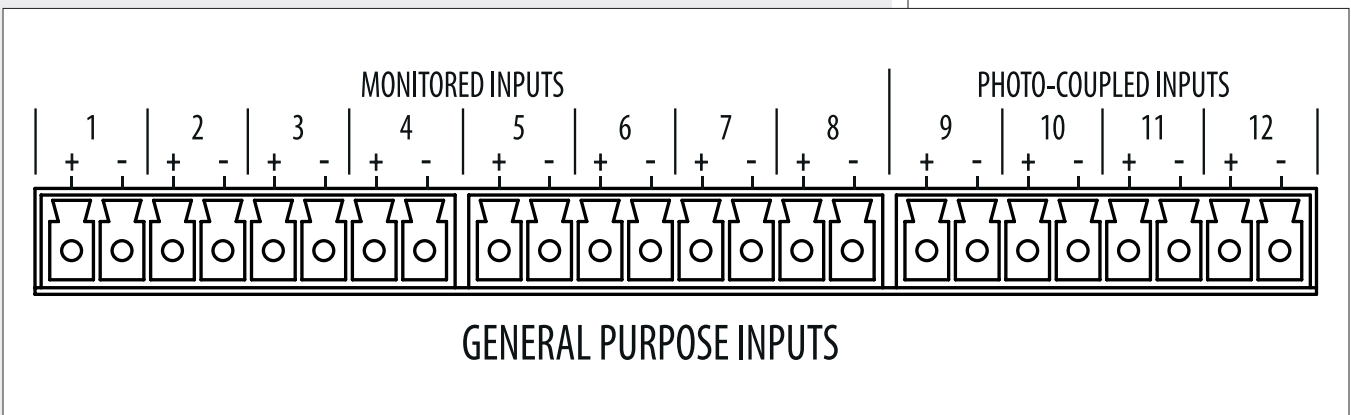

THE LOGICAL INPUTS 9 TO 12 CAN BE ACTIVATED BY CONNECTING THE 24 V DC **49** OUTPUT TO EACH LOGIC INPUT. POSSIBLE LOGIC STATES: INACTIVE / ACTIVE.



LOGIC INPUT 1 ÷ 8 STATES:

STATE		DETECTED RESISTANCE VALUE (R)
OPEN	Open line or too high resistance	$R > 15 \text{ k}\Omega$
SHORT	Short-circuit or too low resistance	$R < 390 \Omega$
IDLE	Used logic input, but inactive	$3.4 \text{ k}\Omega < R < 15 \text{ k}\Omega$
ACTIVE	Activated logic input	$390 \Omega < R < 1.17 \text{ k}\Omega$

SUGGESTED RESISTORS TO BE ADDED TO GET LINE MONITORING:

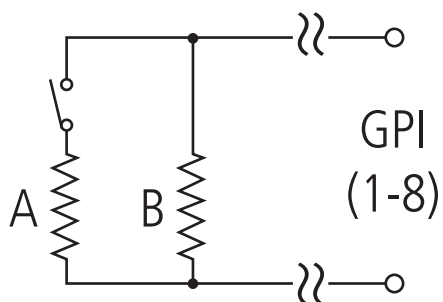

A	B
470 Ω	10 k Ω

49 24 V DC: 24 V dc output, max. 100 mA.

50 GENERAL PURPOSE OUTPUTS

8 logic outputs (relay dry contacts, removable connectors).

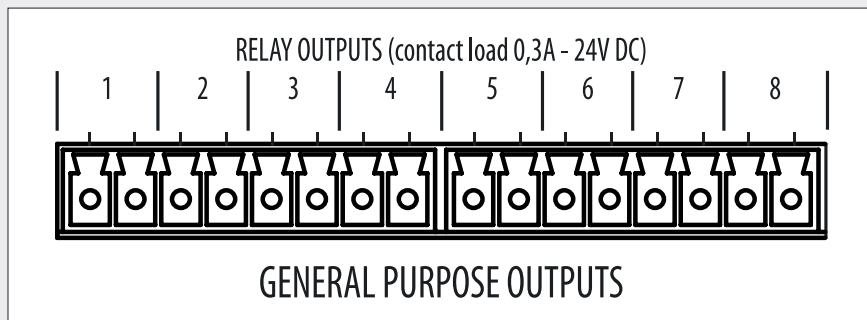

Each logic output has two resistors that can be inserted by setting the respective jumper (JP1 to JP8) to the **AB** position. These two resistors are necessary when the logic output (**GPO**) is linked to a logic input (**GPI**) of another device and the line monitoring is required. The first resistor (470 Ω) is used to get the **ACTIVE** state, the second (10 k Ω) to get the **IDLE** state.

If a jumper is set to the **BC** position, the two resistors are overridden (the internal relay contact is directly connected).

INTERNAL JUMPER SETTING NEEDS TO BE CARRIED OUT DIRECTLY BY EITHER RCF OR AN AUTHORISED SERVICE CENTRE.

WARNING: DO NOT DIRECTLY POWER A LOGIC OUTPUT (**GPO**) WHEN THE RESPECTIVE INTERNAL JUMPER IS SET TO THE **AB** POSITION (INSERTED RESISTORS), AS THE MAX. CURRENT IS ONLY 25 mA. If the JUMPER IS SET TO THE **BC** POSITION, THE MAX. CURRENT IS 0.3 A. MAX APPLICABLE VOLTAGE: 24 V DC.

51 Power cord input (to be connected to a mains earthed socket only).

52 **POWER** switch (0 = OFF, 1 = ON).

53 Input for 48 V dc power supply (removable screw terminals) through batteries.

NOTE: ACCORDING TO EN 54-16 STANDARD, THE BACKUP POWER SUPPLY UNIT SHALL BE INSTALLED INTO THE SAME RACK CABINET WHERE THERE IS THE AUDIO SYSTEM WITH EMERGENCY PURPOSES (OR A SYSTEM PART) TO WHICH IT IS CONNECTED.

THE DETECTION OF 48 V DC POWER SUPPLY INVOLVES THE IMPLICIT CONDITION THAT THE SYSTEM IS ALWAYS TURNED ON, THUS NOT ALLOWING SHUTDOWN OF THE MAIN UNIT THROUGH THE RESPECTIVE FUNCTION IN THE MENU, NOR THROUGH THE **POWER** SWITCH **52**.

54 **DIGITAL AUDIO 1 (MU 9186R ONLY):** 'Audinate Dante' primary network port.

Digital audio channel for shared emergency announcements (in a system with more MU 9186 main units).

If the system includes up to four MU 9186R main units, a second channel is available for shared background music. If there is no redundant 'Dante' network, this is the only port that needs to be connected.

DIGITAL AUDIO 2 (MU 9186R ONLY): 'Audinate Dante' secondary network port.

Connect this port if the 'Dante' network needs to be redundant.

The secondary network is stand-alone and necessarily distinct from the primary, so it shall be linked to dedicated separate network switches (for the secondary network only).

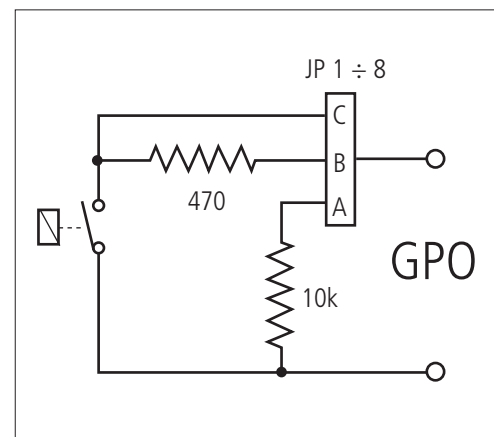
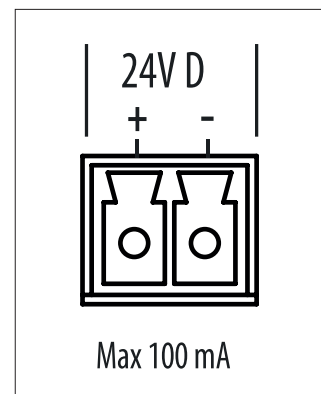



Beside the display, there are 6 buttons **3** (3 on the left, 3 on the right) to select the correspondent displayed options.
The ESC **2** button (below the display, on the right) allows to quit the displayed menu.

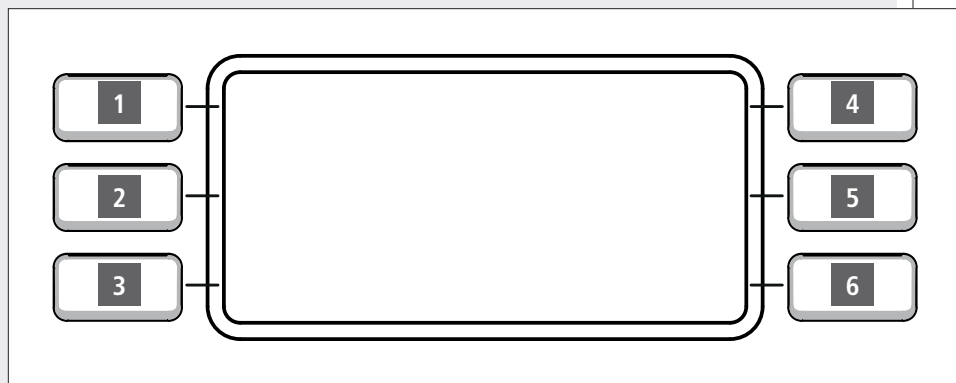

Turn and press the CONTROL SELECTION **4** encoder to select parameters and change their values.

The software initial main menu is shown as MAIN in the top left-hand corner of the display.

The complete menu path is indicated in the top of the display.

In the display bottom: the date (on the left), the time (on the right) and the access level at the centre as follows:

- **L1** (level 1): users not allowed to configure the system
- **L2** (level 2, password required): qualified personnel
- **L3** (level 3, password required): system administrators
- **L4** (level 4, RCF only): system maintenance

MAIN		
EVENT		INFO
DISABL-SURV		SYS LOG
AUDIO SET		SYS CONFIG
01-12-2011	L2	14:11:51



Enter the password in the SYS LOG > LOGIN menu to login and obtain privileges of either level 2 or 3, in order to be allowed to enter other menus / parameters.

Use the SYS LOG > LOGOUT to logout.

ACCESS LEVEL 1 – USERS NOT ALLOWED TO CONFIGURE THE SYSTEM

- Level that allows to enter only a software section, in which it is not possible to edit the system configuration, for example (allowed operations):
- Adjust the MASTER volume (BGM or PAGING)
- Use the MP3 player
- Read the system information.
- The password is not required.

ACCESS LEVEL 2 – QUALIFIED PERSONNEL (password required)

- Level that allows to (in addition to the level 1 functions):
- See the system logs
- Reset emergency events and faults
- Set messages that can be quickly activated through the 6 display buttons.

ACCESS LEVEL 3 – SYSTEM ADMINISTRATORS

Level that allows to configure the system completely: evacuation, pre-recorded emergency messages, logic inputs / outputs (GPI/O), paging microphones, zones, groups, names, remote controls, amplifiers, calibrations, spare units, inputs gains, equalisations, background music (BGM) source selection, etc. .

ACCESS LEVEL 4 – SYSTEM MAINTENANCE

System maintenance by RCF service centres.

After turning the system on, the display shows the MAIN page, from which it is possible to enter the six menus by pressing the respective buttons.

THERE MAY BE MENUS ABOUT CURRENT EVENTS (AS FAULTS OR EMERGENCIES) THAT NEED TO BE VISUALISED: THESE WILL BE UNDERLINED (IN THIS EXAMPLE, 'SYS LOG').



MAIN	
EVENT	INFO
DISABL-SURV	<u>SYS LOG</u>
AUDIO SET	SYS CONFIG
01-12-2011	14:11:51

Functions managed by each menu are briefly described in the following table:

	MENU	DESCRIPTION
1	EVENT	Action required to manage events (evacuation / alert / faults): RESET: it interrupts the event (LED, LCD, audio) SILENT: it mutes the audio signal REACTIVATE: it restores the audio signal LIVE MESSAGE: message playback manual activation.
2	DISABL-SURV	<ul style="list-style-type: none"> - Device disabling. - Amplifier calibration - Spare amplifier setting
3	AUDIO SET	<ul style="list-style-type: none"> - Input / output / monitor settings - MP3 player - Audio matrix - Zone volume
4	INFO	System information
5	SYS LOG	<ul style="list-style-type: none"> - Fault / warning / info log - User LOGIN and LOGOUT.
6	SYS CONFIG	<ul style="list-style-type: none"> - Zone / group settings - Paging microphone / other peripheral settings - Logic inputs (GPI) and outputs (GPO) and configuration of the central unit main features



Menu that allows to act on an event with priority in progress (evacuation, alert) or a fault and start playing a message manually.

RESET: it stops the current event and removes all visual (LED, display) and audio signals. It resets a fault.

SILENT: it stops the audio signal playback matched to the event in progress, but not before its normal ending (the event is fully played at least once).

REACTIVATE: it resumes the playback of the audio signal matched to the event in progress.

LIVE MESSAGE (message playback manual activation): choose both a source (press a key on the left of the display) among SRC 1–2–3 and a destination (press a key on the right of the display) among DEST 1–2–3. After selecting, the message playback will start. Press ESC **2** to stop.

NOTE: SOURCES / DESTINATIONS CAN ONLY BE SET BY THE DEDICATED PC SOFTWARE.



THE OPTIONS NOT SELECTABLE ARE BARRED (DELETED WITH A LINE).



DISABLE-SURV MENU



It is possible to disable system devices, execute amplifier calibrations and set spare amplifiers.

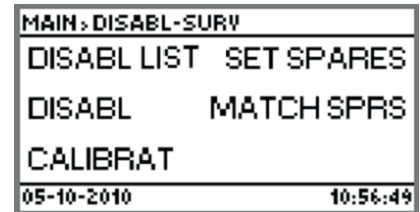

	SUBMENU	DESCRIPTION
1	DISABL LIST	List of all disabled peripherals.
2	DISABL	Disable either a group or a zone or a single peripheral. It inhibits the operation of a device to prevent a error messages during maintenance.
3	CALIBRAT	Calibration of each single amplifier.
4	SET SPARES	Spare amplifier settings.
5	MATCH SPRS	It matches one or more amplifiers (normally used) to a spare one. In case of simultaneous failure of several amplifiers, only the one physically closest (in the chain) is replaced by the spare.

After entering the second submenu **DISABL**, choose among **System** (all the system), **Group** (a group or 'ALL SITE'), **Zone, Boards, Paging console** (it is necessary to select either PAGING 1 or PAGING 2), **Ampli** (amplifiers), **Spk-lines** (loudspeaker lines), **Accessories** (optional devices, i.e. TS 9918 remote controls, etc.).

Two parameters are available for every choice:

ENABLE: It enables (**On**) / disables (**Off**) the selected item.

REQUEST: It enables (**On**) / disables (**Off**) communication with the selected item.

Select the third submenu **CALIBRAT** to carry out the calibration of each single amplifier (note: first it is necessary to choose the amplifier, in the figure, for example, the selected one is 'UP01_AMPL4_A', name that is shown in the menu path in the display top).

EXECUTE: start of the automatic calibration of the selected amplifier loudspeaker line monitoring.

SET ACCURACY: enter to set the monitoring accuracy of the selected amplifier loudspeaker lines.

Choose among 5%, 10%, 15%, 20%, 25%.

SET RING: select either the standard dual output mode (**A & B Out**) or the ring mode (**A Ring B Out**).

The fourth (**SET SPARES**) and the fifth (**MATCH SPRS**) submenus allow to manage spare amplifiers.

In case of failures, the system can automatically replaces faulty amplifiers by the spare ones.

Enter **SET SPARES** to access a further three-option submenu (ADD, REMOVE, LIST) that allows to choose the amplifiers (from the list of all available in the system) to be set to 'spare'.

ADD: choose an amplifier among the ones that are normally operating and add it to the spare amplifier LIST.

REMOVE: remove an amplifier from the spare amplifier LIST.

LIST: it displays the current spare amplifier list.

MATCH SPRS: it sets how the system reacts to a possible amplifier failure. After selecting an amplifier among the ones normally operating, it will be possible to match a spare amplifier list to it.

Priority cannot be set, but is determined depending on the physical location of spare amplifier chain: the faulty amplifier closest to the spare one has the highest priority and is replaced.

After entering this submenu, the list of amplifiers that are not currently set to 'spare' will be displayed. Select an amplifier to proceed and see the next submenu:

ADD SPARE: choose an amplifier among the ones that are normally operating and add it to the 'LIST SPARES' list (that includes all amplifiers already set to 'spare' of the selected one).

REMOVE SPARE: remove a spare amplifier from the list matched to the selected one.

LIST SPARES: spare amplifier list matched to the selected amplifier.

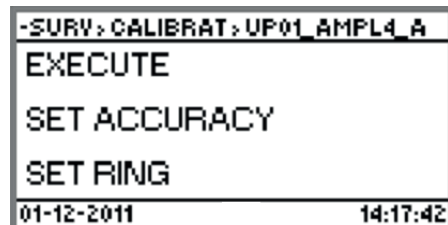



Menu that allows to set input / output parameters, MP3 player operation, audio monitoring, the audio matrix and the MASTER volume.

	SUBMENU	DESCRIPTION
1	INPUTS	System audio input settings (MAIN UNIT / BOARDS).
2	OUTPUTS	System audio output settings.
3	MP3 & MONIT	MP3 player operation and audio monitoring.
4	ROUTN PROG	Routine message settings.
5	RTNG & PRST	Audio matrix configuration.
6	ZONE VOL	Zone volume

AUDIO SET > INPUTS SUBMENU

The **INPUTS** submenu allows to separately edit audio inputs, the MP3 player and main unit pre-recorded messages.

Choose **MAIN UNIT** to enter its list:

1. UNIVERSAL IN (MAIN IN) 40
2. AUX IN 39
3. PAGING A 41
4. PAGING B 42
5. BGM 1 35
6. BGM 2 37
7. BGM 3 38
8. MP3 PLAYER
9. MASTER IN LEVELS:

master volume settings (submenus): BGM VOL (background music), PAG VOL (paging), EMERG VOL (emergency messages), ROUTINE VOL (routine messages). EMERG VOL refers to these messages: EVAC (evacuation), ALERT, ALL-CLEAR and TEST, which are stored to a flash memory and cannot be edited. ROUTINE VOL refers to routine messages store to SD cards (that can be modified).

AUDIO SET > INPUTS SUBMENU

An input selection (1 ÷ 8) opens an editable signal processing parameter list.

MAIN UNIT	LO CUT	5-BAND EQ	COMPRESSOR	AGC	HPL/LPF	3-BAND EQ	LEVEL	VUMETER
UNIVERSAL IN	√	√	√	√			√	
AUX IN	√	√	√				√	
PAGING 1					√	√	√	√
PAGING 2					√	√	√	√
BGM 1					√	√	√	√
BGM 2					√	√	√	√
BGM 3					√	√	√	√
MP3 PLAYER					√	√	√	√

Choose **BOARDS** to enter the slave unit list (i.e. UP 950x amplifiers) and select a board for editing its two local inputs:

1. BGM 3;
2. AUX IN.

Select one of the two local inputs to open an editable signal processing parameter list.

BOARDS	LO CUT	5-BAND EQ	COMPRESSOR	HPL/LPF	3-BAND EQ	LEVEL
BGM 3				√	√	√
AUX IN	√	√	√			√

LO CUT (hi-pass filter)

Filter that cuts low frequencies below the cutoff frequency.
It has a single parameter: the cutoff frequency.

5-BAND EQ

The first band **BAND I LS** is a **low-shelf** filter that increases or decreases the level of all frequencies below the selected one.

The second band **BAND II PK**, the third **BAND III PK** and the fourth **BAND IV PK** are parametric equalizers that allow to adjust the level at the centre frequency and specify the Q factor.

The fifth band **BAND V LS** is a **hi-shelf** filter that increases or decreases the level of all frequencies above the selected one.

PARAMETERS

BAND I LS	FREQ	Frequency setting.
	GAIN	Gain setting (for frequencies below the selected one).
BAND II PK	FREQ	Centre frequency setting.
	GAIN	Gain setting.
	Q	Q factor: a higher value corresponds to a narrower bandwidth.
BAND III PK	Like BAND II PK	
BAND IV PK	Like BAND II PK	
BAND V HS	FREQ	Frequency setting.
	GAIN	Gain setting (for frequencies above the selected one).
BYPASS EQ	Select either ON (equalizer bypassed) or OFF (equalizer inserted).	

COMPRESSOR

The compressor does not modify a signal having a level lower than the predetermined threshold and compresses a signal with a higher level.

The threshold can be set to three different levels: -30 dBu (curve 1), -20 dBu (curve 2), -10 dBu (curve 3).

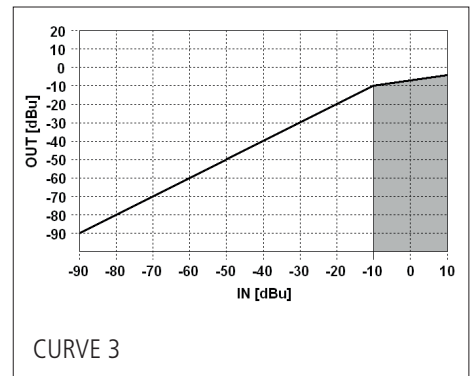
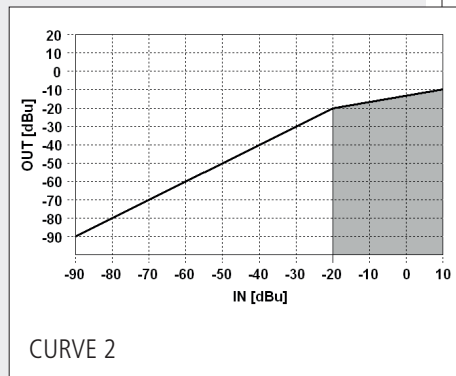
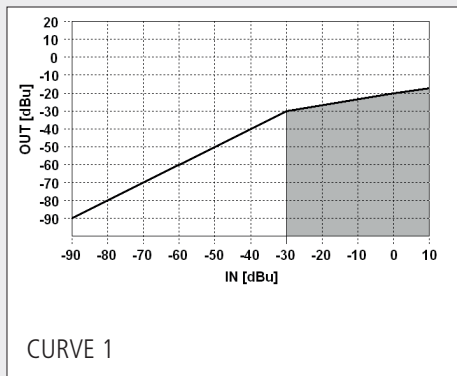

PARAMETERS

ATTACK	Adjusts the compressor attack time.
POST GAIN	Adjusts the output gain (useful to minimize the signal attenuation due to compression).
HOLD	Adjust how long the compression is held after the audio signal returns below the predetermined threshold.
DECAY	Adjusts the compressor release rate.
CURVE	Curve selection: - Curve 1 - Curve 2 - Curve 3
BYPASS	Select either On (compressor bypassed) or Off (compressor inserted).

AGC (automatic gain control)

The automatic gain control can be useful to optimize the output level of an audio input signal extremely variable.

The AGC operates in 5 ways and has two selectable different compressor/limiter modes:

1. NOISE GATE (input signal lower or equal to -70 dBu)
2. EXPANDER (input signal range: -70 to -40 dBu)
3. LINEAR (input signal range: -40 e -10 dBu)
4. COMPRESSOR (input signal range: -10 e -3 dBu in **mode 1**, -10 e $+3$ dBu in **mode 2**)
5. LIMITER (input signal above -3 dBu in **mode 1** or $+3$ dBu in **mode 2**).

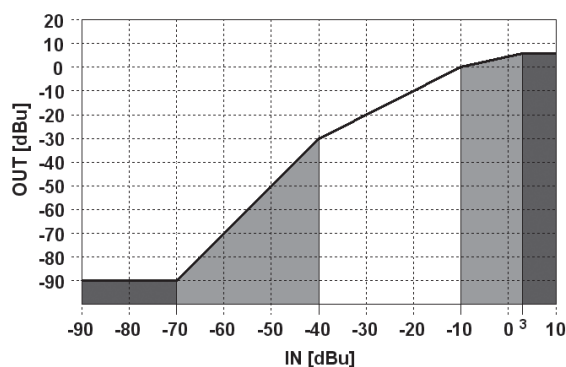
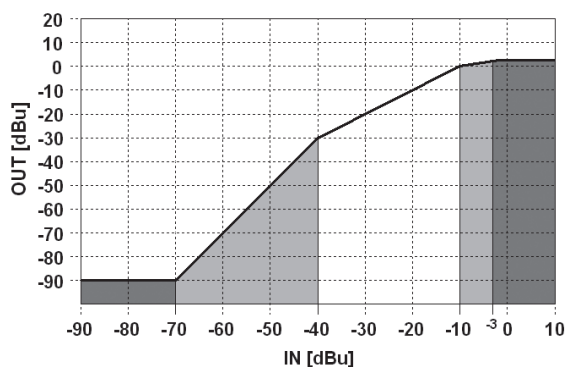

PARAMETERS

VOLUME	Adjusts the max. level (manual limiter).
DECAY	Adjusts the AGC release rate.
CURVE	Mode selection: - Mode 1 - Mode 2
BYPASS	Select either On (AGC bypassed) or Off (AGC inserted).

HPF / LPF (hi-pass filter, low-pass filter)

The hi-pass filter (HPF) cuts low frequencies (below its cutoff frequency), the low-pass filter (LPF) cuts high frequencies (above its cutoff frequency).

PARAMETERS

FREQ HPF	Setting of the hi-pass filter cutoff frequency.
FREQ LPF	Setting of the low-pass filter cutoff frequency.
BYPASS	Select either ON (filters bypassed) or OFF (filter inserted).

3-BAND EQ

The first band **BAND I LS** is a **low-shelf** filter that increases or decreases the level of all frequencies below the selected one.

The second band **BAND II PK** is a parametric equalizer that allows to adjust the level at the centre frequency and specify the Q factor.

The third band **BAND III LS** is a **hi-shelf** filter that increases or decreases the level of all frequencies above the selected one.

PARAMETERS

BAND I LS	FREQ	Frequency setting.
	GAIN	Gain setting (for frequencies below the selected one).
BAND II PK	FREQ	Centre frequency setting.
	GAIN	Gain setting.
	Q	Q factor: a higher value corresponds to a narrower bandwidth.
BAND III HS	FREQ	Frequency setting.
	GAIN	Gain setting (for frequencies above the selected one).
BYPASS EQ	Select either ON (equalizer bypassed) or OFF (equalizer inserted).	

LEVEL

It adjusts the audio input level.

VUMETER

Input signal level indicator.

AUDIO SET > OUTPUTS SUBMENU

Audio output parameter settings.

Choose:

- **Main Unit**, to set the AUX OUT **34**;
- **Boards** (SLAVE units): after selecting a board, its output parameters (OUT 1, 2, 3, 4) can be edited.

Select an output to open an editable signal processing parameter list.

LEVEL

It adjusts the audio output level.

5-BAND EQ

The first band **BAND I LS** is a **low-shelf** filter that increases or decreases the level of all frequencies below the selected one.

The second band **BAND II PK**, the third **BAND III PK** and the fourth **BAND IV PK** are parametric equalizers that allow to adjust the level at the centre frequency and specify the Q factor.

The fifth band **BAND V LS** is a **hi-shelf** filter that increases or decreases the level of all frequencies above the selected one.

PARAMETERS

BAND I LS	FREQ	Frequency setting.
	GAIN	Gain setting (for frequencies below the selected one).
BAND II PK	FREQ	Centre frequency setting.
	GAIN	Gain setting.
	Q	Q factor: a higher value corresponds to a narrower bandwidth.
BAND III PK	Like BAND II PK	
BAND IV PK	Like BAND II PK	
BAND V HS	FREQ	Frequency setting.
	GAIN	Gain setting (for frequencies above the selected one).
BYPASS EQ	Select either ON (equalizer bypassed) or OFF (equalizer inserted).	

**AUDIO SET >
OUTPUTS SUBMENU**

LIMITER

The limiter limits a signal having a higher level than the predetermined threshold. It is in fact a compressor having a high compression ratio. It can be really useful to avoid signal distortion due to too high levels.

PARAMETERS

DECAY	Adjusts the limiter release rate.
BYPASS	Select either ON (limiter bypassed) or OFF (limiter inserted).

DELAY (OUT 1 only)

Audio output delay time setting.

MUTE / UNMUTE Select to mute / unmute the chosen output.

AUDIO SET > MP3 & MONIT SUBMENU

This submenu allows to control the MP 3 player and the audio monitor output, which can be used to listen to the chosen audio channel.

**AUDIO SET >
MP3 & MONIT SUBMENU**

		DESCRIPTION	
MP3 PLAYER	MP3 player (with commands: PLAY, STOP, NEXT, PREV) that loads files on either SD cards or USB flash drives.		
MONITOR	It allows separate listening (adjust its volume through the LEVEL parameter) of an audio channel selected through the SOURCE parameter among: RCF BUS 1/2/3/4 IN, UNIV IN (MAIN IN), PG1/2 (PAGING inputs), AUX IN, BGM1/2/3, MP3, MSG1/2 (messages), DSP OUT 1/2/3/4, RCF BUS 1/2/3/4 OUT, the last audio output edited (AUTO option), NONE. A 3-band equalizer (3-BAND EQ) is present: The first band BAND I LS is a low-shelf filter that increases or decreases the level of all frequencies below the selected one. The second band BAND II PK is a parametric equalizer that allows to adjust the level at the centre frequency and specify the Q factor. The third band BAND III LS is a hi-shelf filter that increases or decreases the level of all frequencies above the selected one. EQ parameters:		
	BAND I LS	FREQ	Frequency setting.
		GAIN	Gain setting (for frequencies below the selected one).
	BAND II PK	GAIN	Centre frequency setting.
		Q	Gain setting.
		FREQ	Q factor: a higher value corresponds to a narrower bandwidth.
	BAND III HS	FREQ	Frequency setting.
		GAIN	Gain setting (for frequencies above the selected one).
BYPASS EQ	Select either ON (equalizer bypassed) or OFF (equalizer inserted).		

AUDIO SET > ROUTN PROG SUBMENU

Submenu that allows to customise routine message playback, which are editable and stored on a SD card.

After selecting the audio file to be played, another 2-option submenu will be displayed: it will be possible to choose to which area the message is sent (**SEL AREA**) and the playback mode (**CONFIG**).

SEL AREA: a message can be routed to either a loudspeaker line (**speaker-line**), a zone (**zone**), a group (**group**), the entire system (**all**) or no area (**none**).

CONFIG: enter to access other three submenus.

**AUDIO SET >
ROUTN PROG SUBMENU**

SET PRIO	Priority level setting (lower number: higher priority).		
PERIODIC	TIME	START TIME	Playback start time setting.
		STOP TIME	Playback stop time setting.
		INTERVAL	Time interval between two message playbacks over a period of time set by START TIME and STOP TIME.
	SCHEDULE	Play Daily	Daily playback.
		Play Weekly	Weekly playback.
		Mo to Fr	Playback only on working days (Monday to Friday).
		Sa & Su	Playback only on Saturdays and Sundays.
		Mondays	Playback only on Mondays.
		Tuesdays	Playback only on Tuesdays.
		Wednesdays	Playback only on Wednesdays.
		Thursdays	Playback only on Thursdays.
		Fridays	Playback only on Fridays.
		Saturdays	Playback only on Saturdays.
		Sundays	Playback only on Sundays.
ENABLE	On: message enabled, Off: message disabled.		

AUDIO SET > RTNG & PRST SUBMENU

Submenu concerning the audio matrix and stored presets.
It includes 3 different functions:

RCFBUS TRANSPORT: choice of audio sources sent to the 4-channel bus.
The selection of the bus channel (among BUS 1, BUS 2, BUS 3, BUS 4) to be set is made through the **CONTROL SELECTION** encoder. Then it is necessary to choose audio sources (divided into 'static' **BACKGROUND SOURCE** and **DYNAMIC SOURCE**).

AUDIO SOURCES ARE DIVIDED INTO 2 CATEGORIES:

- a. **STATIC**, NOT ACTIVATED BY EVENTS: BACKGROUND MUSIC INPUTS **BGM 1-2-3**, **MP3** PLAYER.
- b. **DYNAMIC**, ACTIVATED BY EVENTS: PAGING MICROPHONE INPUTS **PAGING 1-2**, **AUX IN**, **UNIV IN** (MAIN IN), PRE-RECORDED MESSAGES **MSG 1-2**.

AUDIO ASSIGN: enabling zones, groups or the entire system, to receive the selected audio sources.

As soon as the entire system (**ALL**), a **GROUP**, a **ZONE**, a **MAIN BOARD** bus or a slave peripheral (**BOARDS**) is selected, it will be necessary to choose the assigned audio source (see the following table).

		BGM 1	BGM 2	BGM 3	MP3	BUS 1-4	UNIV IN	PG 1-2	AUX IN	MSG 1-2	OUT 1-4	INT. SINE	NONE / ZERO
ALL		√	√	√	√								√
GROUP		√	√	√	√								√
ZONE		√	√	√	√								√
MAIN BOARD (BUS OUT selection)		√	√	√	√	√	√	√	√	√			
BOARDS	OUT 1-4			√		√			√				√
	MONITOR			√		√			√		√	√	√

PG: PAGING input
MSG: message
INT.SINE: sine wave for testing.
NONE / ZERO: no selection.

ROUTING PRESET: preset store and recall.
When choosing this function, another submenu is displayed:

LOAD: it loads a preset, updating RCFBUS TRANSPORT and AUDIO ASSIGN settings.

SAVE: current RCFBUS TRANSPORT and AUDIO ASSIGN settings are saved to a selected preset (among 64).

INFO: information about the current preset.

AUDIO SET > RTNG & PRST SUBMENU



AUDIO SET > ZONE VOL SUBMENU

After selecting a zone (through submenus), it is possible to adjust the volume of background music (BGM VOL), paging (PAG VOL), emergency messages (EMERG VOL) and routine messages ROUTINE VOL.

EMERG VOL refers to these messages: EVAC (evacuation), ALERT, ALL-CLEAR and TEST, which are stored to a flash memory and cannot be edited.

ROUTINE VOL refers to routine messages stored to SD cards (that can be modified).

AUDIO SET > ZONE VOL SUBMENU

INFO MENU



Enter **INFO** menu to get information about the system.

	FUNZIONE	DESCRIPTION
1	LED TEST	Check of all LEDs, which light up for a few seconds (a text message will be displayed).
2	DEVICE INFO	Information about the CPU state and system devices. Choose among: <ul style="list-style-type: none"> - Main Unit - Boards - Paging console (select either PAGING 1 or 2) - Ampli (amplifiers) - Accessories: optional devices (i.e. TS 9918 remote controls, etc.).
3	DATA COMM	Information about RCF BUS , RDNET BUS , USB ports, ETHERNET.
4	ABOUT	Firmware information.

MAIN.INFO	
LED TEST	ABOUT
DEVICE INFO	
DATA COMM	
13-10-2010	13:59:47



Menu from which it is possible to access all logs and user LOGIN / LOGOUT.



	FUNCTION	DESCRIPTION
1	SYS LOG	Log including all system events. Select a single event to get information about it.
2	EMERG LOG	Log including all system emergency events (evacuation / alert). Select a single event to get information about it.
3	FAULT LOG	Log including all system faults / failures. Select a single fault to get information about it.
4	ACTION LOG	Log including all emergency parameter settings (emergency volume, emergency paging microphones, FALL BACK, etc.).
5	LOGIN	<p>User login (to get respective privileges) by entering its password.</p> <p>Rotate the CONTROL/SELECTION 4 encoder to change each of the four numbers (0÷255) that make up the code and press it to confirm. Press ESC 2 to return to the previous number.</p>
6	LOGOUT	User logout.

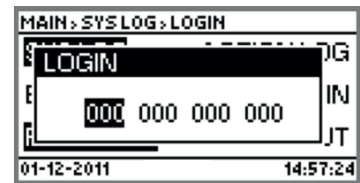



The SYS CONFIG menu allows to:

- Set zones / groups
- Set paging microphones and other peripherals
- Set logic inputs (GPI) and outputs (GPO)
- Access the generic system settings.

	SUBMENU	DESCRIPTION
1	ZONE-GRP	System group / zone settings.
2	PAG CONS	Paging microphone settings.
3	GPI-VOX	Logic input (GPI) and VOX function settings.
4	GPO	Logic output (GPO) settings.
5	REM-N&D	Peripheral settings and 'Night & Day' presets.
6	SETTINGS	Generic system settings.

MAIN > SYS CONFIG	
ZONE-GRP	GPO
PAG CONS	REM-N&D
GPI-VOX	SETTINGS
05-10-2010	14:36:31

SYS CONFIG > ZONE-GRP SUBMENU

Enter this submenu to edit system groups / zones.

The system can be divided into many groups, which are made of one or more zones.

This involves some advantages, especially in terms of time. For example, a group setting is normally applied to all devices that belong to it.

A zone is made by one or more amplifier outputs, a group by one or zones.

The two loudspeaker outputs that belong to the same amplifier channel cannot be assigned to different zones.

It is possible to have up to 31 SLAVE devices (UP 9501 - UP 9502 - UP 9504 amplifiers, 128 groups, 128 zones and 128 loudspeaker lines.

To add, modify or remove a group, simply see the existing group list. Choose **SET GROUP**, then select the group that needs to be edited and use one of the following functions:

	FUNCTION	DESCRIPTION
1	ADD ZONE	Add a (previously unselected) system zone to the group.
2	REMOVE ZONE	Remove a zone from the group.
3	LIST ZONE	List of all zones that belong of the selected group.
4	ENABLE	Enable (On) / Disable (off) the selected group.

SYS CONFIG > ZONE-GRP SUBMENU

Similarly, for single zones, use **SET ZONE**:

	FUNCTION	DESCRIPTION
1	ADD SPKR-LINE	Assign a (previously unselected) loudspeaker line (an amplifier channel) to the zone.
2	REMOVE SPKR-LINE	Remove a loudspeaker line (an amplifier channel) from the zone.
3	LIST SPKR-LINE	List of all loudspeaker lines (amplifier channels) that belong to the selected zone.
4	ENABLE	Enable (On) / Disable (off) the selected zone.

SYS CONFIG > PAG CONS SUBMENU

Submenu for paging microphone settings (max. 16). The system can have max. 8 paging microphones for each of the two PAGING 1, 2 ports of the main unit.

The first paging microphone of each line can be set for emergency use (EMERG option in the CONFIG menu). This microphone (unlike the others) is monitored and has the emergency button enabled.

After choosing one of the two PAGING port, select one of the available paging microphone to enter a further submenu having 3 options:

SYS CONFIG > PAG CONS > PAGING x > Paging Console n

CONFIG: it allows to set a specific priority level and the emergency functions (enabling the test of the paging microphone and its capsule).

BUTTONS FUNCTION: paging microphone button settings.

BUTTONS DEFAULT: it restores the button factory default settings (group/zone selection through a digital address matched to a button).

Advanced settings can only be made though the dedicated PC software.

The common paging microphone buttons are:

- PTT ('Push To Talk'): microphone activation
- GEN CALL: all call
- CHIME: chime enabling
- EMERGENCY: emergency button.

Depending on the paging microphone model, there may be additional buttons (EXT BUTTONS, max. 64), 3 configurable MAIN BUTTONS or a numeric keyboard.

Being assembled in groups of 8, the EXT BUTTONS are available in 9 possible configurations (in multiples of 8): 0, 8, 16, 24, 32, 40, 48, 56, 64.

For all buttons (but CHIME), it is possible to assign a logic output (GPO) chosen among those of the MASTER unit and / or an available SLAVE unit.

Enter **CONFIG** to access the following parameters:

- **SET PRIO:** priority setting (lower number: higher priority)
- **EMERG:** enable (**On**) or disable (**Off**) the emergency function.

After entering **BUTTONS FUNCTION**, select a button to be set among:

- **EMERGENCY**
- **GEN CALL** (all call)
- **PTT BUTT**
- **MAIN/EXT** (other buttons).

SYS CONFIG > PAG CONS SUBMENU

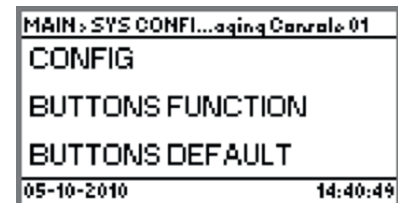

Select EMRG to enter its respective submenu:

SYS CONFIG > PAG CONS > PAGING x > Paging Console n > BUTTONS FUNCTION > EMRG

ENABLED: it enables (On) / disables (Off) the button for the emergency function.

ASSIGN: it opens a further submenu.

- **EVENT MSG:** it sets an evacuation / alert event, in which a message chosen among the ones on flash memory is played. The message playback is continuous until the event ends due to a 'reset'.
- **TALK:** it enables (On) / disables (Off) the microphone (during the message playback).
- **DESTINATION:**
 - **USE ZONE BUTT:** it enables (On) / disables (Off) the zone buttons for emergency purpose.
 - **SEL AREA:** it limits the emergency event area to a **ZONE**, a **GROUP** or let it be the entire system (**ALL**); **NONE:** no selection.
- **PRIORITY:** an emergency button can have a priority level different from the paging microphone setting (lower number: higher priority).

IN THE **ASSIGN** MENU, SET THE TALK PARAMETER TO ON TO ENABLE THE MICROPHONE. IT IS ANYWAY NECESSARY TO PUSH THE PTT BUTTON TO TURN THE MICROPHONE ON AND STOP THE MESSAGE THAT IS ASSIGNED TO AN EVENT (THE MICROPHONE HAS HIGHER PRIORITY THAN A MESSAGE).

THE MICROPHONE TURNS OFF AFTER A RESET.

DELAY: it allows to delay actions related to button pressure and release.

It opens a further submenu:

- **ACTIVATION TIME:** delay time setting of the start of the function assigned to the button after its pressure.
- **RELEASE TIME:** delay time setting of the end of the function assigned to the button after its release.
- **OVERRIDE:** the assigned function can be cancelled if another button is pressed (selected in the **MAIN/EXT BUTT** submenu), a main unit logic input is activated (**MAIN UNIT GPI**), a slave board logic input is activated (**BOARDS GPI** submenu).

GPO TRIG: assignment of a logic output (GPO) to the emergency button.

Select the logic output of either the main unit (**MAIN UNIT GPO** submenu) or a slave board (**BOARDS GPO** submenu).

Select **GEN CALL** to enter its respective submenu:

SYS CONFIG > PAG CONS > PAGING x > Paging Console n > BUTTONS FUNCTION > GEN CALL

SEL AREA: general call button paging area selection. It can be either a specific zone (ZONE submenu), a group (**GROUP**), all system zones (**ALL ZONE SYS**) or only those configured in the paging microphone (**ALL ZONE PAG**).

GPO TRIG: assignment of a logic output (GPO) to the general call button.

Select the logic output of either the main unit (**MAIN UNIT GPO** submenu) or a slave board (**BOARDS GPO** submenu).

Select **PTT BUTT**, to enter a single function:

SYS CONFIG > PAG CONS > PAGING x > Paging Console n > BUTTONS FUNCTION > PTT BUTT

GPO TRIG: assignment of a logic output (GPO) to the PTT button.

Select the logic output of either the main unit (**MAIN UNIT GPO** submenu) or a slave board (**BOARDS GPO** submenu).

(!) > BUTTONS FUNCTION > EMERGENCY	
ENABLED	GPO TRIG
ASSIGN	
DELAY	
29-09-2010	10:40:46



(!) > BUTTONS FUNCTION > GEN CALL	
SEL AREA	
GPO TRIG	
29-09-2010	10:50:32

(!) > BUTTONS FUNCTION > PTT BUTT	
GPO TRIG	
05-10-2010	14:59:10

Select **MAIN/EXT** and (then) either a MAIN (BM 9802 / BM 9804) or a EXT (BE 9808) zone button to enter a 4-option submenu:

SYS CONFIG > PAG CONS > PAGING x > Paging Console n > BUTTONS FUNCTION > MAIN/EXT > (Main 1)

ENABLED: it enables (**On**) / disables (**Off**) the selected button.

ASSIGN

Selection that allows to:

- Define events (**Event Generation**), such as evacuation (**EVAC**), alert (**ALERT**), all clear (**ALL CLEAR**), test (**TEST**), by selecting the destination area (**DEST**).
- Execute a 'reset' (**Event Reset**), interrupt (**Event Silent**) or reactivate (Event Reactivate) audio signal assigned to events.
- Start a routine message (**Play Message**) stored to a SD card.
- Turn the volume up/down (**Level BGM, UP / DOWN**) of a background music signal (BGM1, BGM2, BGM3, MAIN IN, AUX IN, selected through **SEL BGM**), either mute (**Mute BGM**) or unmute it (**Unmute BGM**).
- Load a preset (**Load Preset**) chosen among the existing ones of the audio matrix, in order to change the allocation of audio signals on the 4-channel RCF bus.
- **Fault Acknowledge.**
- Zone selection (**Zone Button → ALL, GROUP, ZONE**).

DELAY: it allows to delay actions related to button pressure and release.

It opens a further submenu:

- **ACTIVATION TIME:** delay time setting of the start of the function assigned to the button after its pressure.
- **RELEASE TIME:** delay time setting of the end of the function assigned to the button after its release.
- **OVERRIDE:** the assigned function can be cancelled if another button is pressed (selected in the **MAIN/EXT BUTT** submenu), a main unit logic input is activated (**MAIN UNIT GPI**), a slave board logic input is activated (**BOARDS GPI** submenu).

GPO TRIG: assignment of a logic output (GPO) to buttons.

Select the logic output of either the main unit (**MAIN UNIT GPO** submenu) or a slave board (**BOARDS GPO** submenu).

Select **BUTTON DEFAULT** to restore (/ initialise) button default settings.

SYS CONFIG > PAG CONS > PAGING x > Paging Console n > BUTTONS DEFAULT

BTTONS FUNCTION :MAIN/EXT : Main 1	
ENABLED	GPO TRIG
ASSIGN	
DELAY	
29-09-2010	10:50:51

SYS CONFIG > GPI-VOX SUBMENU

Settings of the 12 logic inputs (GPI) of the main unit (and amplifiers) and the MAIN IN VOX function.

'VOX' IS A FUNCTION THAT AUTOMATICALLY DETECTS THE AUDIO SIGNAL PRESENCE (ABOVE A PREDEFINED THRESHOLD) ON THE MAIN IN INPUT.

Choose either **MAIN UNIT GPI** to access the main unit GPI list or **BOARD GPI** to access the selected board GPI list.

NOTE: IN THE GPI LIST, LOGIC INPUTS THAT HAVE ALREADY BEEN ASSIGNED ARE MARKED BY A DOT IN BRACKETS AFTER THEIR NAMES.

Select a logic input to enter its respective submenu:

CONFIG:

SET PRIO	Priority setting (lower number: higher priority).
MONITORING	It enables (On) / disables (Off) GPI line monitoring.
STATUS	GPI default status. Choose either Normal Open or Normal Close (normally open/closed).
ENABLE	It enables (On) / disables (Off) the selected GPI.

ASSIGN: selection of the function to be assigned to the logic input (see the following table).

FUNCTION	DESCRIPTION
NO FUNCTION	No function assigned to the logic input (GPI).
MUTE	It allows to mute a channel or an amplifier that belongs to either a zone, a group or the entire system.
UNMUTE	It allows to unmute a channel or an amplifier that belongs to either a zone, a group or the entire system.
EVENT RESET	Reset.
EVENT SILENT	It stops playing the message that is assigned to an evacuation / alert event.
EVENT REACTIVATE	It resumes the playback of the message that is assigned to an evacuation / alert event and has been previously stopped.
EVENT GEN	It creates an event, chosen among evacuation, alert, all clear, fault and test. It allows to select the message to be assigned to the event (the choice is among 8 messages per event type) and the destination area (note: this is not possible in case of fault indication).
ROUTINE MESSAGE	Playback of a routine message (chosen among the ones available on the used SD card) due to the activation of a logic input (GPI).
LOAD PRESET	It loads a preset (among 64), to change the allocation of audio signals on the 4-channel RCF bus.
NIGHT&DAY VOL	Selection from a preset list (up to 32) to set the audio level at night.
AUX IN ROUTING	It sends MAIN IN / AUX IN to a group or a zone.
PSU FAULT	The logic input is used to control the secondary power supply (48 V dc).

SYS CONFIG > GPI-VOX SUBMENU

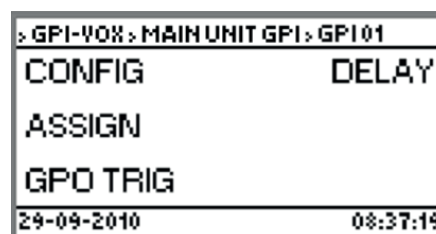
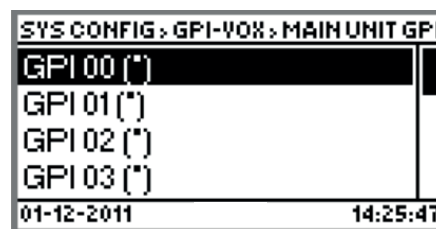

GPO TRIG: assignment of a GPO (chosen among either the main unit ones MAIN UNIT GPO or BOARDS GPO) to a GPI.

DELAY: it allows to delay actions related to GPI activation and release.

It opens a further submenu:

- **ACTIVATION TIME:** delay time setting of the start of the function assigned to the GPI after its activation.
- **RELEASE TIME:** delay time setting of the end of the function assigned to the GPI after its release.
- **OVERRIDE:** it is possible to cancel the function assigned to a logic input if either a main unit GPI (MAIN UNIT GPI) or a slave board GPI (BOARDS GPI) is here selected and then activated.

Select **VOX** to enter a 6-option submenu:

SET PRIO: VOX priority level setting (lower number: higher priority).

SEL AREA: selection of the area assigned to the VOX function among a zone (**ZONE** submenu), a group (**GROUP**), all system zones (**ALL**), no zone (**NONE**).

GPO TRIG: assignment of a logic output (GPO) to the VOX function.

DELAY: it allows to delay actions related to the VOX function activation and release.

It opens a further submenu:

- **ACTIVATION TIME:** setting of the delay time before opening the audio input from the VOX function activation.
- **RELEASE TIME:** setting of the delay time before muting the audio input from the VOX function release.
- **OVERRIDE:** it is possible to cancel the VOX function if a paging microphone button is pressed (selected in the **MAIN/EXT BUTT** submenu), a main unit logic input is activated (**MAIN UNIT GPI**), a slave board logic input is activated (**BOARDS GPI** submenu).

GAIN-PHANT: to enter a further 2-option submenu.

- **GAIN:** VOX function threshold setting from 0 (low threshold) to 7 (high threshold).
- **PHANTOM:** it turns **On / Off** the Phantom power on the MAIN IN input.

ENABLED: it enables (**On**) / disables (**Off**) the VOX function.

<(!)> SYS CONFIG > GPI-VOX > VOX	
SET PRIO	DELAY
SEL AREA	GAIN-PHANT
GPO TRIG	ENABLE
29-09-2010	10:50:32

SYS CONFIG > GPO SUBMENU

Configuration of the 8 logic outputs (GPO) of the main unit (and of all amplifiers).

Choose either **MAIN UNIT GPO** to access the main unit GPO list or **BOARD GPO** to access the selected board GPO list.

Then, select a logic output (GPO) to enter its respective submenu:

CONFIG:

SET PRIO	Priority setting (lower number: higher priority).
MONITORING	It enables (On) / disables (Off) GPI line monitoring.
STATUS	GPI default status. Choose either Normal Open or Normal Close (normally open/closed).
ENABLE	It enables (On) / disables (Off) the selected GPO.

ASSIGN: logic output mode and function settings (see the following table).

FUNCTION	DESCRIPTION
NO FUNCTION	No function assigned.
PERIODIC	Its activation is repeated once or more times (TIME) or in defined days (SCHEDULE). As example, see the AUDIO SET > ROUTN PROG submenu.
ROUTINE MESSAGE	Its activation is due to routine message playback (a message chosen among the ones matched to events).
FAULT IN PROGRESS	Its activation is due to a fault detection.
EVAC IN PROGRESS	Its activation is due to evacuation in progress.
ALERT IN PROGRESS	Its activation is due to alert in progress.
ALL-CLEAR IN PROGRESS	Its activation is due to the 'all clear' message playback.
TEST IN PROGRESS	Its activation is due to the 'test' message playing.
BUSY ZONE	Its activation is due to a busy zone.

DELAY: it allows to delay GPO activation and release.

It opens a further submenu:

- **ACTIVATION TIME:** delay time setting of GPO activation.
- **RELEASE TIME:** delay time setting of GPO release.
- **OVERRIDE:** it is possible to cancel the GPO activation if either a main unit GPI (MAIN UNIT GPI) or a slave board GPI (BOARDS GPI) is here selected and then activated.

SYS CONFIG > GPO SUBMENU

NFIG > GPO > MAIN UNIT GPO > GPO 01	
CONFIG	
ASSIGN	
DELAY	
29-09-2010	09:20:04

SYS CONFIG > REM-N&D SUBMENU

This submenu allows to:

- Set system peripherals, but those managed separately, such as paging microphones.
- Edit 'Night and Day' volume presets.

Enter to see the following lists:

- **REM CTRL:** remote (volume and programme) controls. Note: this function is currently disabled and will be available in future software releases.
- **N&D PRESET:** 'Night and Day' volume preset settings.
- **NOISE DETECT:** ambient noise detectors.

NOTE: THIS FUNCTION IS CURRENTLY DISABLED AND WILL BE AVAILABLE IN FUTURE SOFTWARE RELEASES.

'Night & Day' volume preset selection is not (of course) a peripheral, but an operating mode setting that changes paging and background music volume in predetermined times or due to logic input (GPI) activations.

It is possible to store (and load) up to 32 'Night and Day' presets.

Select a 'Night and Day' preset (**N & D PRESET**) to enter its respective submenu:

SYS CONFIG > REM-N&D > N & D PRESET > PRESET N&D XX

SEL AREA: area selection affected by the 'Night and Day' preset, chosen among the entire system (**ALL**), a group (**GROUP**), a zone (**ZONE**); **NONE:** no selection.

CONFIG: enter to access other three submenus.

SYS CONFIG > REM-N&D SUBMENU

SET PRIO	Priority level setting (lower number: higher priority).		
PERIODIC	TIME	START TIME	'Night and Day' function start time setting.
		STOP TIME	'Night and Day' function stop time setting.
	SCHEDULE	Play Daily	Daily 'Night and Day' function.
		Play Weekly	Weekly 'Night and Day' function.
		Mo to Fr	'Night and Day' function only on working days (Monday to Friday).
		Sa & Su	'Night and Day' function only on Saturdays and Sundays.
		Mondays	'Night and Day' function only on Mondays.
		Tuesdays	'Night and Day' function only on Tuesdays.
		Wednesdays	'Night and Day' function only on Wednesdays.
		Thursdays	'Night and Day' function only on Thursdays.
		Fridays	'Night and Day' function only on Fridays.
		Saturdays	'Night and Day' function only on Saturdays.
		Sundays	'Night and Day' function only on Sundays.
		ENABLE	On: 'Night and Day' function enabled, Off: 'Night and Day' function disabled.

LEVELS

For each 'Night and Day' preset, it is possible to adjust (through submenus) its levels: BGM VOL (background music), PAG VOL (paging), EMERG VOL (emergency messages), ROUTINE VOL (routine messages).

EMERG VOL refers to these messages: EVAC (evacuation), ALERT, ALL-CLEAR and TEST, which are stored to a flash memory and cannot be edited.

ROUTINE VOL refers to routine messages stored to SD cards (that can be modified).

SYS CONFIG > SETTINGS SUBMENU

Generic system settings.

FUNCTION	DESCRIPTION
Date & Time	Date (Set Date) and time (Set Time) settings. It is possible to select the (Date Format) and the (12h / 24h) Time Format .
Diff On Emergency	Emerg. Sources Only: when an emergency is in progress (i.e. evacuation), all other signals are muted. All Sources: all signals are kept (i.e. background music) in areas not involved by an emergency in progress.
Diff when Busy Zones	If set to On , paging and message playback are allowed even if some zones are busy.
Set Password	Password setting for either level 2 or 3.
Sys Reset/Off	System reset or shutdown.
Discovery	It starts the RDNET network scan in order to find all present devices, to which the main unit assigns digital ID addresses in ascending order (the closest ones have lowest ID). If it is necessary to replace, add or remove, for instance, an amplifier or a paging microphone, the 'Discovery' function will need to be restarted. In this case, the installer shall be sure that the new network architecture (with new ID addresses) is compatible with the previous settings. Scanning is carried out on either slave BOARDS or paging microphone line 1 (PAGING 1) or line 2 (PAGING 2).
FallBack Enable	FALL BACK input enabling (On) / disabling (Off).
Save Current Config	Save the current configuration.

SYS CONFIG >
SETTINGS SUBMENU



THE MASTER MU 9186 IS NAMED **MAIN UNIT**.

GROUPS: GROUP LIST

Group names can be changed by using a dedicated software for PC.
The enabled groups are marked by a dot in brackets after their names.



MAIN > DISABL-SURV > DISABL > Group	
Group 00 (*)	
Group 01	
Group 02	
Group 03	
01-12-2011	14:42:43

ZONES: ZONE LIST

Zone names can be changed by using a dedicated software for PC.
The enabled zones are marked by a dot in brackets after their names.

MAIN > DISABL-SURV > DISABL > Zone	
Zone 00 (*)	
Zone 01 (*)	
Zone 02	
Zone 03	
01-12-2011	14:50:36

BOARDS: SLAVE BOARD LIST

All SLAVE boards (labelled RCF40) are listed in this format:

aaxx:RCF40 yy

- aa:** device type,
UP = UP 9501, UP 9502, UP 9504 amplifiers
- xx:** ID address
- yy:** progressive index

MAIN > DISABL-SURV > DISABL > Board	
UP05: RCF40 04	
UP06: RCF40 05	
UP07: RCF40 06	
SC08: RCF40 07	
01-12-2011	14:51:49

SLAVE board names can be changed by using a dedicated software for PC.

AMPLIFIERS: AMPLIFIER LIST

All available amplifiers are listed in this format:

aaxx_AMPLn_PAy

- aa:** device type,
UP = UP 9501, UP 9502, UP 9504 amplifiers
MX= MX 9502, MX 9504 MASTER units with amplifiers
- xx:** ID address
- n:** amplifier number (1, 2, 4)
- y:** amplifier channel (1, 2, 3, 4)

MAIN > DISABL-SURV > DISABL > Ampli	
UP02_AMPL4_PA3	
UP02_AMPL4_PA4	
UP03_AMPL2_PA1	
UP03_AMPL2_PA2	
01-12-2011	14:52:37

SPK-LINES: LOUDSPEAKER LINE LIST

All available loudspeaker lines are listed in this format:

aaxx_AMPLn_PAy_z

- aa:** device type,
MX= MX 9502, MX 9504 MASTER units with amplifiers
UP = UP 9501, UP 9502, UP 9504 amplifiers
- xx:** ID address
- n:** amplifier number (1, 2, 4)
- y:** amplifier channel (A, B, C, D)
- z:** loudspeaker line

MAIN > DISABL-SURV > DISABL > Spk-Liner	
UP02_AMPL4_PA3_C	
UP02_AMPL4_PA4_D	
UP03_AMPL2_PA1_A1	
UP03_AMPL2_PA1_B1	
01-12-2011	14:53:52

DISPLAY TEXT MESSAGES



DISPLAY TEXT MESSAGES	DESCRIPTION
AC NOT AVAILABLE	Mains AC power supply not available.
AC HIGH	Mains AC power supply: too high voltage.
AC LOW	Mains AC power supply: too low voltage.
AC FUSE FLT	Mains AC power supply: blown or not present fuse.
DC NOT PRESENT	48 V DC (batteries) power supply not available.
DC HIGH	48 V DC (batteries) power supply: too high voltage.
DC LOW	48 V DC (batteries) power supply: too low voltage.
DC FUSE FLT	48 V DC (batteries) power supply: blown or not present fuse.
STND-BY PSU VOLTAGE NOT AVAILABLE	Faulty internal 'stand-by' power supply unit.
STND-BY PSU VOLTAGE HIGH	Internal 'stand-by' power supply unit: too high voltage.
STND-BY PSU VOLTAGE LOW	Internal 'stand-by' power supply unit: too low voltage.
STND-BY PSU VOLTAGE FUSE FLT	Internal 'stand-by' power supply unit: blown or not present fuse.
SYS OK	System operating properly.
SYS FLT	Generic system fault.
FLT COMMUNICATION CONNECTION (peripheral)	No data transmission between the main unit and a system peripheral.
FALLBACK ANNOUNCEMENT IN PROGRESS	Emergency announcement (with highest priority) in progress through the audio FALL BACK INPUT 32 .
EVAC EVENT IN PROGRESS	Evacuation in progress.
ALERT EVENT IN PROGRESS	Alert in progress.
SPEAKER LINE xx DISABLED	Loudspeaker line disabled.
AMPLIFIER xx DISABLED	Amplifier disabled.
ZONE xx DISABLED	Zone disabled.
GROUP xx DISABLED	Group disabled.
DEVICE xx DISABLED	Device disabled (remote control, ambient noise detector).
PAGING MICROPHONE xx DISABLED	Paging microphone disabled.
FALLBACK MICROPHONE xx DISABLED	Emergency audio FALL BACK input disabled.
EMERGENCY MESSAGES CORRUPTED	Emergency message memory failure.
EMERGENCY MESSAGES NOT AVAILABLE	Emergency messages not available.
EMERGENCY MESSAGES AUDIO OUT UNAVAILABLE	The emergency message player cannot be routed to system audio outputs.
MICROPROCESSOR xx HAS BEEN RESET	Microprocessor reset.
MICROPROCESSOR xx FLT	Microprocessor fault.

DISPLAY TEXT MESSAGES	DESCRIPTION
MAIN POWER SUPPLY FAULT	Internal main power supply unit fault.
MAIN POWER SUPPLY OVERHEAT	Internal main power supply unit overheat.
MAIN POWER SUPPLY OVERLOAD	Internal main power supply unit overload.
xx POWER SUPPLY VOLTAGE NOT AVAILABLE	Issue in a device power supply.
EXTERNAL PSU FAULT	External power supply unit fault (indicated through a logic input).
LOCAL FAULT	Local fault (indicated on the faulty device only).
FAULT COMMUNICATION /CONNECTION WITH MAIN UNIT	Failure of a device linked to RS 485 (remote volume / programme control, ambient noise detector, etc.).
EMERGENCY PAGING PANEL xx NOT AVAILABLE	Failure of an emergency paging microphone (a FALL BACK microphone or a standard paging microphone set to EMERGENCY via software).
DATA COMMUNICATION LINE FLT	Paging microphone line fault (data).
AUDIO COMMUNICATION LINE FLT	Paging microphone line fault (audio path).
SYSTEM POWER SUPPLY FLT	Paging microphone: failure in the power supply from the main unit.
REMOTE/LOCAL POWER SUPPLY FLT	Paging microphone local power supply failure.
REMOTE/LOCAL POWER SUPPLY HIGH	Paging microphone local power supply: too high voltage.
REMOTE/LOCAL POWER SUPPLY LOW	Paging microphone local power supply: too low voltage.
MICROPHONE CAPSULE FLT	Emergency paging microphone: microphone capsule fault.
MICROPHONE CAPSULE NOT AVAILABLE	Emergency paging microphone: microphone capsule not detected.
AMPLIFIER xx OVERLOAD	Amplifier overload.
AMPLIFIER xx OVERHEAT	Amplifier overheat.
FANs FLT	Amplifier cooling fan failure.
AUDIO SIGNAL FLT	Issue in the audio signal sent to amplifiers.
EMERGENCY LOUDSPEAKER ZONE FAULT xx	Loudspeaker line (for emergency purposes) fault.
IMPEDANCE HIGH	Loudspeaker line: too high impedance.
IMPEDANCE LOW	Loudspeaker line: too low impedance.
LINE OPEN	Loudspeaker line: open circuit.
LINE OPEN – LOOP ACTIVATED	Loudspeaker line (loop): open circuit.
LINE SHORTED	Loudspeaker line: short circuit.
SPKR LINE GND LEAKAGE	Loudspeaker line: earth leakage.
SERIAL PORT COMM. FLT	RS 485: data transmission fault.
SERIAL PORT CONNECT FLT	RS 485: connection fault.
SERIAL PORT CONN. SHORTED	RS 485: short circuit.
SERIAL PORT CONN. OPEN	RS 485: open line.
SERIAL DEVICE xx NOT AVAILABLE	RS 485: device not detected / available.
REMOTE DEVICE NOT CONNECTED	Open line linked to a monitored logic input (GPI) / output (GPO).
CONN. SHORTED	Short-circuited line linked to a monitored logic input (GPI) / output (GPO).

MU 9186 – JUMPER SETTINGS



IMPORTANT: INTERNAL JUMPER SETTING SHALL BE CARRIED OUT ONLY BY EITHER RCF OR AN AUTHORISED SERVICE CENTRE.



Remove the lid and look at the back GPI / GPO board (in this drawing, the 10 jumpers are marked in grey inside the rectangle):

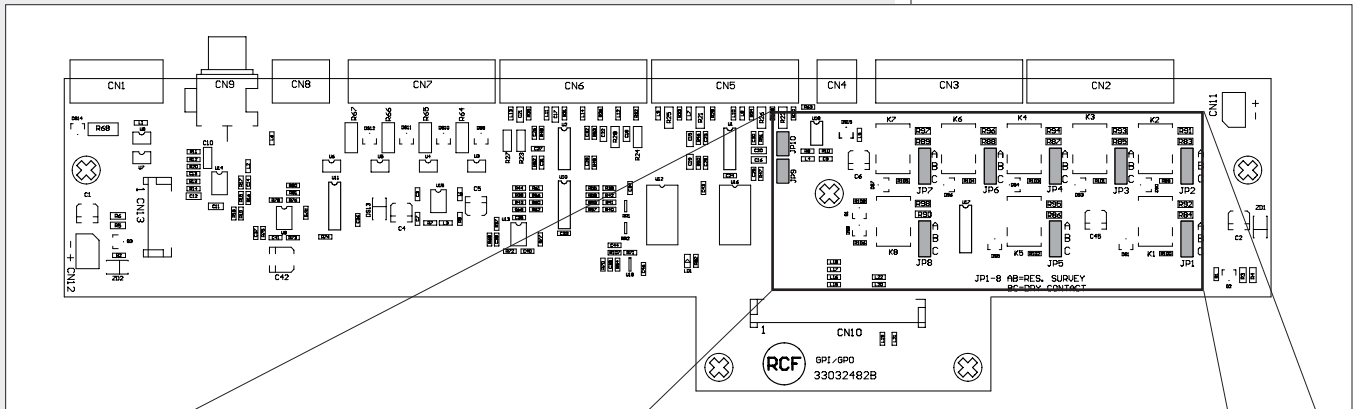

ZOOM:

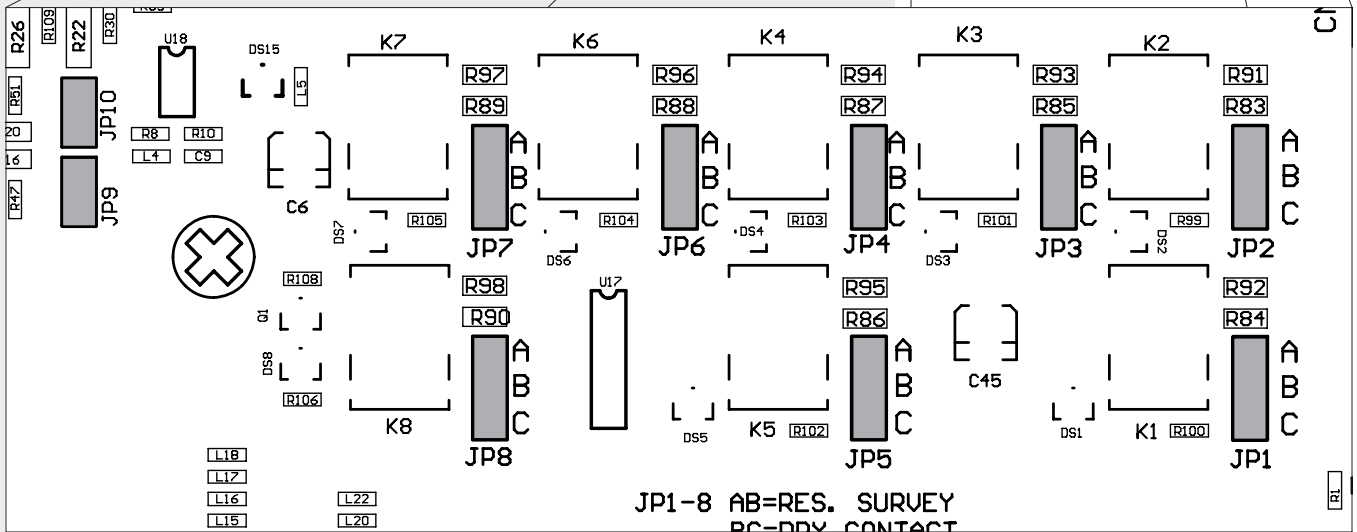

JP1 to JP8	AB position: the two resistors for monitoring are inserted in the respective logic output (GPO).	BC position: the two resistors for monitoring are not inserted ('dry contact') in the respective logic output (GPO).
JP 9	Jumper inserted (ON): normal operation of the first logic input (GPI 1), which can be connected to a dry closing contact.	Jumper removed (OFF): the first logic input (GPI 1) can be linked to an external device having its own output voltage.
JP 10	Jumper inserted (ON): normal operation of the second logic input (GPI 2), which can be connected to a dry closing contact.	Jumper removed (OFF): the second logic input (GPI 2) can be linked to an external device having its own output voltage.

CONNECTION EXAMPLE

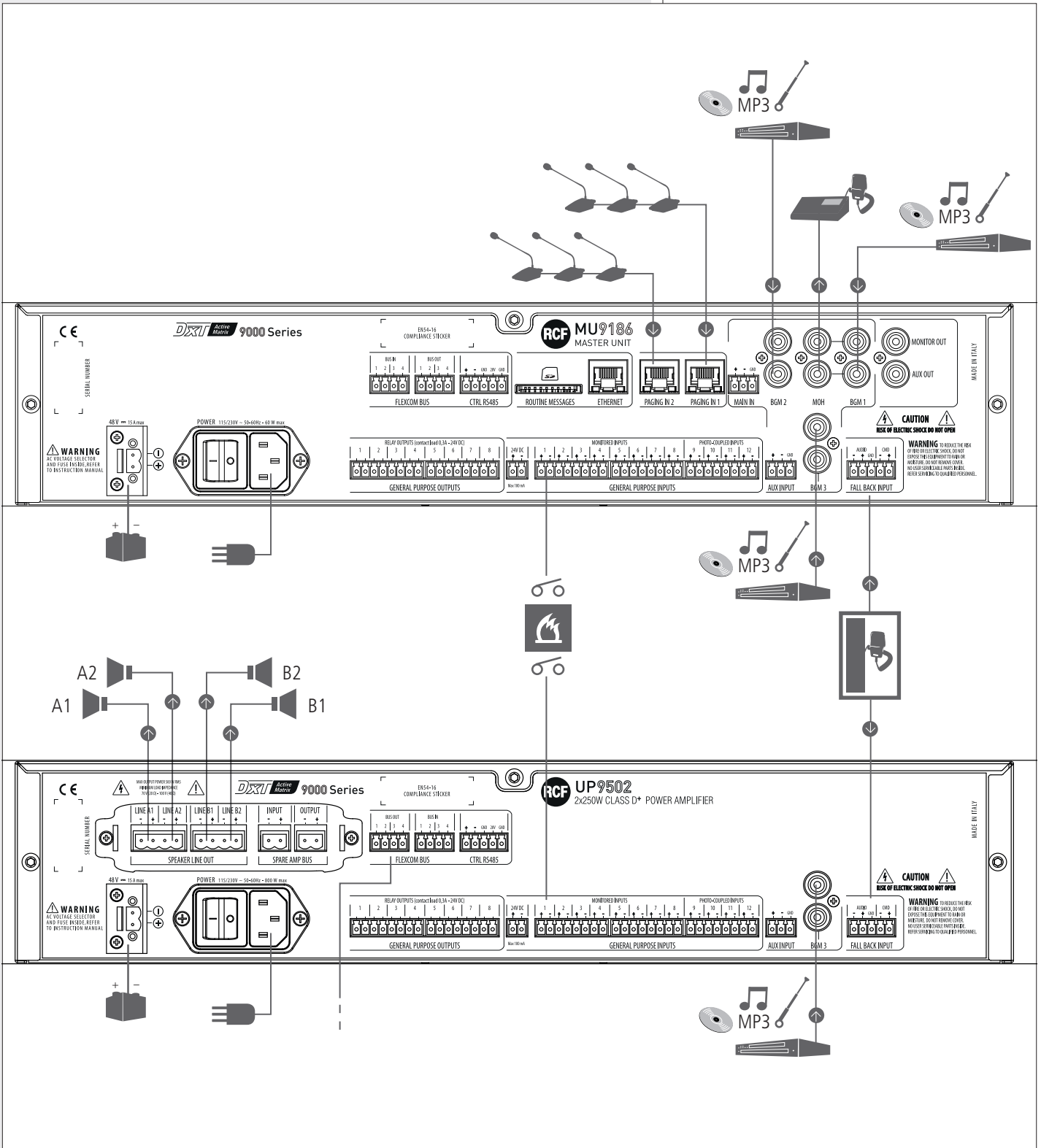



RCF SPA GIVES THE FOLLOWING MAINTENANCE INDICATIONS IN ORDER TO KEEP THE SYSTEM OPERATING PROPERLY

EVERY FORTNIGHT:

- Check if the ventilation grilles of the equipment inside the rack cabinet are not obstructed.
- Verify all paging microphone cable connections.
- Verify paging mic. goosenecks are not damaged.
- Test all paging consoles make by making selective announcements

EVERY 2 MONTHS:

- Disconnect the mains (230V ac) and verify if the system keeps operating properly when powered by the EN 54-4 system (dc).
- Test the evacuation message.
- Test the alert message.
- Verify if the alarm reset command still works properly.

EVERY 2 YEARS:

- Replace all batteries of the EN 54-4 system.





INTERNAL RACK WIRING

- Ethernet: CAT5E cable (ANSI/TIA/EIA-568-A).
- Optic fiber: depending on the type of optical SFP transceiver used (necessarily 'rugged' and suitable for use in industrial environments), you can use any type of single-mode or multimode cable.
- Paging microphones: either CAT5 / CAT5E cable (ANSI/TIA/EIA-568-A) or an 8-pole fire retardant cable with the following specs:
 - Fire resistant EN 1363 -1 DIN 4102 -12
 - Fire retardant VDE 0472 Part 804-C, BS 4066 Part 3 (NMV 1,5), IEC 332-3 cat.CF
 - Markings VDE 0815, EN 50200 PH 120, EN 60332-1-2, EN 61034-2, FIPEC(EN)
Such as RCF CJ 428E fire retardant multipole cable.
- GPIO: either CAT5 / CAT5E cable (ANSI/TIA/EIA-568-A) or an 8-pole fire retardant cable with the following specs:
 - Fire resistant EN 1363 -1 DIN 4102 -12
 - Fire retardant VDE 0472 Part 804-C, BS 4066 Part 3 (NMV 1,5), IEC 332-3 cat.CF
 - Markings VDE 0815, EN 50200 PH 120, EN 60332-1-2, EN 61034-2, FIPEC(EN)
Such as RCF CJ 428E fire retardant multipole cable.
- RCFBUS Flexcomm: either CAT5 / CAT5E cable (ANSI/TIA/EIA-568-A) or a 4-pole / 8-pole fire retardant cable with the following specs:
 - Fire resistant EN 1363 -1 DIN 4102 -12
 - Fire retardant VDE 0472 Part 804-C, BS 4066 Part 3 (NMV 1,5), IEC 332-3 cat.CF
 - Markings VDE 0815, EN 50200 PH 120, EN 60332-1-2, EN 61034-2, FIPEC(EN)
Such as RCF CJ 228E / CJ 428E fire retardant multipole cable.

EXTERNAL CABLES TO RACK

- Optic fiber: depending on the type of optical SFP transceiver used (necessarily 'rugged' and suitable for use in industrial environments), you can use any type of single-mode or multimode cable.
- Paging microphones: 8-pole fire retardant cable with the following specs:
 - Fire resistant EN 1363 -1 DIN 4102 -12
 - Fire retardant VDE 0472 Part 804-C, BS 4066 Part 3 (NMV 1,5), IEC 332-3 cat.CF
 - Markings VDE 0815, EN 50200 PH 120, EN 60332-1-2, EN 61034-2, FIPEC(EN)
Such as RCF CJ 428E fire retardant multipole cable.
- GPIO: 8-pole fire retardant cable with the following specs:
 - Fire resistant EN 1363 -1 DIN 4102 -12
 - Fire retardant VDE 0472 Part 804-C, BS 4066 Part 3 (NMV 1,5), IEC 332-3 cat.CF
 - Markings VDE 0815, EN 50200 PH 120, EN 60332-1-2, EN 61034-2, FIPEC(EN)
Such as RCF CJ 428E fire retardant multipole cable.
- RCFBUS Flexcomm: 4-pole / 8-pole fire retardant cable with the following specs:
 - Fire resistant EN 1363 -1 DIN 4102 -12
 - Fire retardant VDE 0472 Part 804-C, BS 4066 Part 3 (NMV 1,5), IEC 332-3 cat.CF
 - Markings VDE 0815, EN 50200 PH 120, EN 60332-1-2, EN 61034-2, FIPEC(EN)
Such as RCF CJ 228E / CJ 428E fire retardant multipole cable.
- Speakers: 2-pole fire retardant cable suitable for the delivered amplifier power and with the following specs:
 - Fire resistant EN 1363 -1 DIN 4102 -12
 - Fire retardant VDE 0472 Part 804-C, BS 4066 Part 3 (NMV 1,5), IEC 332-3 cat.CF
 - Markings VDE 0815, EN 50200 PH 120, EN 60332-1-2, EN 61034-2, FIPEC(EN).

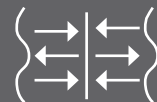

In the DXT 9000 system, monitoring of the integrity of speaker lines is made through impedance measurement at subsonic frequency (20 Hz).

This method was chosen because of its good stability and accuracy of calculated values, which avoids false line fault reports that often occur with impedance measurements faster at supersonic frequencies, but more prone to interferences and errors.

To use the DXT 9000 line monitoring properly, so that it fully complies with the European Safety Standard EN 54-16, it is strictly necessary to consider the functional limitations of all devices.

The two main limitations are:

- Measurable impedance range.
- The minimum / maximum tolerance compared to the calibration value of the measurement for the line fault detection.

Let us now analyse in detail these two limitations.

MEASURABLE IMPEDANCE RANGE

There are three amplifier models that differ in their power, so each has its own measurable impedance range:

- Single channel amplifier (max. power: 500 W).
- Dual channel amplifier (max. power: 250 W per channel).
- Four-channel amplifier (max. power: 125 W per channel).

In a 100 V (or 70 V) constant voltage line, the minimum measurable impedance **Zmin** can be estimated (in all the three cases) considering a load having double the maximum output power **Pmax** on a single line (and ignoring the efficiency of speakers and approximating the impedance at 20 Hz with the real one; the phasor impedance at 20 Hz is only 9 degrees out of phase with the real axis).

$$Z_{min_{100V}} = \frac{(100 \text{ V})^2}{2 P_{max}} \quad \text{or} \quad Z_{min_{70V}} = \frac{(70.7 \text{ V})^2}{2 P_{max}}$$

The results are:

1 x 500 W → **Zmin** = 10 Ω (at 100 V), **Zmin** = 5 Ω (at 70 V)

2 x 250 W → **Zmin** = 20 Ω (at 100 V), **Zmin** = 10 Ω (at 70 V)

4 x 125 W → **Zmin** = 40 Ω (at 100 V), **Zmin** = 20 Ω (at 70 V)

The maximum measurable impedance **Zmax** can be estimated considering lines loaded to a quarter of the maximum output power **Pmax**.

$$Z_{max_{100V}} = \frac{(100 \text{ V})^2}{0.25 P_{max}} \quad \text{or} \quad Z_{max_{70V}} = \frac{(70.7 \text{ V})^2}{0.25 P_{max}}$$

The results are:

1 x 500W → **Zmax** = 80 Ω (at 100 V), **Zmax** = 40 Ω (at 70 V)

2 x 250W → **Zmax** = 160 Ω (at 100 V), **Zmax** = 80 Ω (at 70 V)

4 x 125W → **Zmax** = 320 Ω (at 100 V), **Zmax** = 160 Ω (at 70 V)

MEASURABLE IMPEDANCE RANGE

Amplifiers are protected and designed to operate at their maximum rated power.

The best impedance range (Z_{mon}), in which its measurement is more stable, immune to errors and repeatable, is **from 50% to 100% of the load corresponding to the maximum power** of the channel.

With 100 V lines:

- 1 x 500 W → $20 \Omega \leq Z_{mon} \leq 40 \Omega$
- 2 x 250 W → $40 \Omega \leq Z_{mon} \leq 80 \Omega$
- 4 x 125 W → $80 \Omega \leq Z_{mon} \leq 160 \Omega$

With 70 V lines:

- 1 x 500 W → $10 \Omega \leq Z_{mon} \leq 20 \Omega$
- 2 x 250 W → $20 \Omega \leq Z_{mon} \leq 40 \Omega$
- 4 x 125 W → $40 \Omega \leq Z_{mon} \leq 80 \Omega$

Note that (depending on amplifiers and tolerances of sensors) measures higher or lower than the indicated limits can be similarly accurate and valid. These values shall be considered as 'confidence thresholds' of the line control.

In fact, sensors could measure impedances (at 20 Hz) in the 5 ÷ 400 Ω range. Measuring of impedances out of that range may be prone to errors and interferences.

TOLERANCE COMPARED TO THE CALIBRATION VALUE

The choice of the speaker line impedance tolerance is important in order to avoid these two cases:

- Too low tolerance: every little interference will cause a false line fault.
- Too high tolerance: the system will not report any fault even with a line damage that excludes most speakers.

EN54-16 standard requires the system to indicate speaker line faults (short or open circuits) and not a single speaker fault. Therefore, a single speaker fault is tolerable, but not the loss of a line section.

In a 100 / 70 V line all speakers are linked in parallel, so a short circuit (total impedance tends to zero) leads to the opening of the entire speaker line.

The choice of the tolerance (five options: 5%, 10%, 15%, 20%, 25%) is important to get a proper speaker line monitoring.

Consider the following general rule:

"The recommended tolerance value is the highest of the available options, but lower than the weight of the smallest percentage change in impedance, usually due to the disconnection of the speaker having the highest impedance and installed at the end of a line branch."

A COUPLE OF EXAMPLES:

1. Two speaker lines are linked in parallel and connected to a 250 W amplifier output.

The total impedance is 40 Ω (Z_{tot}).

The line 1 ends with a speaker having an impedance 600 Ω (Z_{maxend}).

The line 2 ends with a speaker having an impedance 200 Ω .

Since all speakers are linked in parallel, in case of **disconnection of the 600 Ω speaker**, the line total impedance will change from 40 Ω (Z_{tot}) to 42.8 Ω (Z_{noend}).

TOLERANCE COMPARED TO THE CALIBRATION VALUE

The following formula is basically the calculation of the impedances in parallel:

$$Z_{noend} = \frac{Z_{maxend} \times Z_{tot}}{Z_{maxend} - Z_{tot}}$$

NOTE: THE LINE IMPEDANCE HERE IS CONSIDERED AT THE FREQUENCY OF 20 Hz (WHICH IS NOT EQUAL TO THE ONE MEASURED BY AN IMPEDANCE METER AT 1 kHz)!



The percentage difference between the two impedances is **7.14%**, so it is necessary to set the tolerance to the **5%** option.

2. Three speaker lines are linked in parallel and connected to a 500 W amplifier output. The total impedance is 50 Ω (**Z_{tot}**).

The line 1 ends with a speaker having an impedance 140 Ω.

The line 2 ends with a speaker having an impedance 220 Ω.

The line 3 ends with a speaker having an impedance 350 Ω.

Since all speakers are linked in parallel, in case of **disconnection of the 350 Ω speaker**, the line total impedance will change from 50 Ω to 58.3 Ω.

The percentage difference between the two impedances is **16.6%**, so it is necessary to set the tolerance to the **15%** option.

However, there are many cases where the weight percentage of the last speaker is less than 5%, often making impossible to detect any damage to the line.

Moreover, there are speakers (e.g. horns) that are virtually open circuits at the frequency of 20 Hz, making it impossible to measure the line impedance.

In these cases, it is strictly necessary to connect (at the end of lines) devices having an impedance (at 20 Hz) that allows the calibration (in the proper range of each channel) and low enough to make it possible to detect the opening of the last line segment.

These devices are just named '**End Of Line**', hereafter abbreviated as EOL.

EOL ('END OF LINE'): FEATURES AND USE GUIDELINES

EOL are reactive loads having an impedance 200 Ω at the resonance frequency (20 Hz). Absorbing reactive power only, EOL can be added to a speaker line without affecting the rated power of its amplifier. However, this is valid if considering the dynamic of the impedance meter, which can properly measure up to a maximum load of twice the rated amplifier power.

To ensure proper line monitoring when the constrain of the last speaker of various line branches (explained in the previous paragraph) is not respected, it will be necessary to add an EOL at the end of each line branch.

For each amplifier model, there is a maximum number of EOL (and line branches) that can be added to a single line. This is due to problems of dynamics of the impedance measuring circuit and the amplifier (eddy currents need to be considered, as these can overload the amplifier).

- Max. 5 EOL for each line linked to a **500 W** amplifier output.
- Max. 4 EOL for each line linked to a **250 W** amplifier output.
- Max. 2 EOL for each line linked to a **125 W** amplifier output.

EOL ('END OF LINE'): FEATURES AND USE GUIDELINES

The total impedance (**Ztot**) resulting from the parallel between the load impedance already present in the line (**Zline**) and EOL (**Zeol** = 200 Ω) is easily obtainable by the following formula:

$$\mathbf{Z_{tot}} = \frac{\mathbf{Z_{line}} \times \mathbf{Z_{eol}}}{\mathbf{Z_{line}} - \mathbf{Z_{eol}}}$$

NOTE: THE LINE IMPEDANCE (**Zline**) HERE IS CONSIDERED AT THE FREQUENCY OF 20 Hz (WHICH IS NOT EQUAL TO THE ONE MEASURED BY AN IMPEDANCE METER AT 1 kHz)!

In case of a single line having a particularly low impedance load or lines including horn speakers (open circuits at 20 Hz), it will be necessary to add more EOL in parallel.

In case the line is divided into more branches, in each branch the EOL number needs to be the same, in order to guarantee a proper monitoring and respect the following formula:

$$\mathbf{Neol} = \text{EOL number}$$

$$\mathbf{Neol} > = \frac{\mathbf{200 \Omega}}{\mathbf{Z_{tot} (21 - N_{branch})}}$$

Ztot = total impedance
Nbranch = line branch number

Within the system operation limits, the result is equal to 1 in almost all cases. The only exception is given by a line with two branches including horn speakers only and connected to a 500 W amplifier. In this case, it is advisable to add two EOL (in parallel) to the end of each line branch (to fall within the correct measurement range).

Anyway, to know how many EOL are needed in a line, it is necessary to calculate the total impedance (**Ztot**) by applying the following formula (parallel impedances), adjusted with the EOL number (**Neol**):

$$\mathbf{Z_{tot}} = \frac{\mathbf{Z_{line}} \times \frac{\mathbf{200 \Omega}}{\mathbf{Neol}}}{\mathbf{Z_{line}} + \frac{\mathbf{200 \Omega}}{\mathbf{Neol}}}$$

NOTE: THE LINE IMPEDANCE (**Zline**) HERE IS CONSIDERED AT THE FREQUENCY OF 20 Hz (WHICH IS NOT EQUAL TO THE ONE MEASURED BY AN IMPEDANCE METER AT 1 kHz)!

The total impedance must respect the constraints about EOL. EOL number shall not exceed the maximum amount (as indicated previously).





MAIN IN, FALL BACK INPUT audio inputs	
- Input sensitivity:	-50 ÷ +6 dBu
- Frequency response (±3 dB):	20 Hz ÷ 20 kHz
- Input impedance (1 kHz):	25 kΩ
- Signal / noise ratio:	104 dB
- FALL BACK command voltage:	24 V dc
PAGING IN (1, 2) audio inputs	
- Input sensitivity:	-60 ÷ -20 dBu
- Frequency response (±3 dB):	200 Hz ÷ 16 kHz
- Input impedance (1 kHz):	4 kΩ
- Signal / noise ratio:	84 dB
- Paging console power supply:	24 ÷ 28 V dc
AUX INPUT	
- Input sensitivity:	-50 ÷ +6 dBu
- Frequency response (±3 dB):	20 Hz ÷ 20 kHz
- Input impedance (1 kHz):	25 kΩ
- Signal / noise ratio:	94 dB
BGM (1, 2, 3) audio inputs	
- Input sensitivity:	-50 ÷ +6 dBu
- Frequency response (±3 dB):	20 Hz ÷ 20 kHz
- Input impedance (1 kHz):	25 kΩ
- Signal / noise ratio:	90 dB
MONITOR OUT, AUX OUT, MOH audio outputs	
- Max. output level:	1 W on 8 Ω
- Output impedance (1 kHz):	60 Ω
- Frequency response (±3 dB):	20 Hz ÷ 20 kHz
- Distortion (THD+N @1W, 1kHz):	≤ 0.01%
GPI (logic inputs)	
- Monitored GPI number:	8
- Photo-coupled GPI number:	4
GPO (logic outputs)	
- Max. applicable voltage:	24 V dc
- Max. current:	0.3 A
RCF FLEXCOM BUS	
- Channels:	4
- Resolution:	24 bits
- Sampling frequency:	44.1 kHz
24 V DC output	
- Max. output current:	100 mA
DATA LINK	
- 1 LAN ETHERNET connector	
- 2 PAGING IN RJ 45 ports	
- 1 RS485 EUROBLOCK connector	
- 2 RCF FLEXCOM BUS EUROBLOCK connectors	
ELECTRICAL SPECS.	
- Operating voltage:	115/230 V ac (50-60 Hz), 48 V dc
- Max. consumption (power):	60 W
- Operating temperature:	-5 ÷ +50 °C (23 ÷ 122 °F)
- Relative humidity:	20 ÷ 90% (non-condensing)
MECHANICAL SPECS.	
- Dimensions (w, h, d):	485 mm, 88 mm, 365 mm (19" rack - 2 units)
- Net weight:	6.9 kg

**DXT 9000 - COMPLIANCE OPTION LIST WITH EN 54-16 REQUIREMENTS**

- 7.3 Audible warning
- 7.6.2 Manual silencing of the voice alarm condition
- 7.7.2 Manual reset of the voice alarm condition
- 7.8 Output to fire alarm devices
- 8.3 Indication of faults related to the transmission path to CIE
- 9. Disablement condition
- 10. Voice alarm manual control
- 11. Interface to external control device(s)
- 12. Emergency microphone(s)
- 13.14 Redundant power amplifiers



0068

RCF S.p.A. - Via Raffaello Sanzio 13, 42124 Reggio Emilia, ITALY

14

0068-CPR-002/2014

EN 54-16:2008

Voice alarm control and indicating equipment for fire detection and fire alarm systems for buildings

DXT 9000

Provided options

- 7.3 Audible warnings
- 7.6.2 Manual silencing of the voice alarm condition
- 7.7.2 Manual reset of the voice alarm condition
- 7.8 Output to fire alarm devices
- 7.9 Voice alarm condition output
- 8.3 Indication of faults related to the transmission path to the CIE
- 9 Disablement condition
- 10 Voice alarm manual control
- 11 Interface to external control device(s)
- 12 Emergency microphone(s)
- 13, 14 Redundant power amplifiers

DoP: 008_17

Other technical data: see operational manual.

Except possible errors and omissions.
RCF S.p.A. reserves the right to make modifications without prior notice.

www.rcf.it



RCF S.p.A. Italy
Via Raffaello Sanzio, 13
42124 Reggio Emilia - Italy
Tel +39 0522 274 411
Fax +39 0522 232 428
e-mail: info@rcf.it