

HL RGBW-S

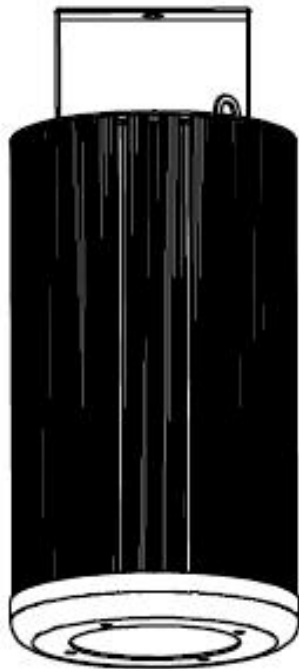

USER Manual

Please read it carefully

Menu

1. Safety Guideline.....	2
2. Technical Parameter.....	3
3. Parts	3
4. Installation	4
4.1. Hoisting	4
4.2. DMX512 Connection	4
5. Lighting Setting Parrameter Reset	5
5.1. Control panel	5
5.2. Main Function	5
6. Lighting Control	8
6.1. Master/Slave Built In Preprogrammed Function	8
6.2. DMX Controller	8
6.3. DMX Channel	9
7. DMX512 configuration	10
8. Troubleshooting	11
9. Fixture Cleaning	11

1. Safety Guideline



WARNING

Please read the instruction carefully which includes important information about the installation, usage and maintenance.

Please keep this User Guide for future consultation. If you sell the unit to another user, be sure that they also receive this instruction manual.

Important:

Damages caused by the disregard of this user manual are not subject to warranty. The dealer will not accept liability for any resulting defects or problems.

- ① Unpack and check carefully that there is no transportation damage before using the unit.
- ① The unit is for indoor use only. Use only in a dry location.
- ① DO install and operate by qualified operator.
- ① DO NOT allow children to operate the fixture.
- ① The unit must be installed in a location with adequate ventilation, at least 50cm from adjacent surfaces.
- ① Be sure that no ventilation slots are blocked, otherwise the unit will be overheated.
- ① Before operating, ensure that the voltage and frequency of power supply match the power requirements of the unit.
- ① It's important to ground the yellow/green conductor to earth in order to avoid electric shock.
- ① Maximum ambient temperature TA: 40°C.
- ① DO NOT connect the device to any dimmer pack.
- ① During initial start-up some smoke or smell may arise. This is a normal process and does not necessarily mean that the device is defective, and it will decrease gradually within 15 minutes.
- ① Make sure there are no flammable materials close to the unit while operating to avoid fire hazard.
- ① Examine the power wires carefully; replace them immediately if there is any damage.
- ① Unit's surface temperature may reach up to 65°C. DO NOT touch the housing bare-handed during its operation, and allow about 15 minutes for cooling the unit down before replacing bulb or maintenance as it could be very hot.
- ① Avoid any inflammable liquids, water or metal objects entering the unit. Once it happens, cut off

the mains power immediately.

- ⓘ DO NOT operate in dirty or dusty environment, do clean fixtures regularly.
- ⓘ DO NOT touch any wire during operation as there might be a hazard of electric shock.
- ⓘ Avoid power wires together twist other cables.
- ⓘ DO NOT open the unit as there are no user serviceable parts inside.
- ⓘ Never try to repair the unit by yourself. Repairs carried out by unskilled people can lead to damage or malfunction. Please contact the nearest authorized technical assistance center if needed.
- ⓘ Disconnect the mains power if the fixture is has not been used for a long time.
- ⓘ DO use the original packing materials before transporting it again.

Cautions:

- ⓘ To prevent or reduce the risk of electrical shock or fire, do not expose the unit to rain or moisture.
- ⓘ DO replace the bulb once it is damaged, deformed or life-expired.
- ⓘ DO NOT look directly at the light while the bulb is on.
- ⓘ Never touch bulb with bare fingers, as it is very hot after using.
- ⓘ DO NOT start on the unit when housing is damaged.

2. Technical Parameter:

1. Input Voltage:	AC 100~240V, 50/60Hz
2. Total Power consumption:	72W
3. LED Sources:	CREE LED
4. Beam Angle:	35° or 60°
5. Color: *	RGBW linear color mixing
6. Color Temperature:	color cast calibration setting、 color temperature output inside device
7. Dimmer:	0-100% linearly dimming, 5 types dimmer modes, smooth dimming, flicker-free;
8. Shutter:	independent electronic strobe;
9. Control Mode:	Standard DMX512
10. channel modes:	4,5,7, 9 CH;
11. Waterproof Grade	IP20
12. Work Environment Temperature	-20°C~40°C

13.Dimension:

303x175x175mm

14.N.W:

3.25Kgs

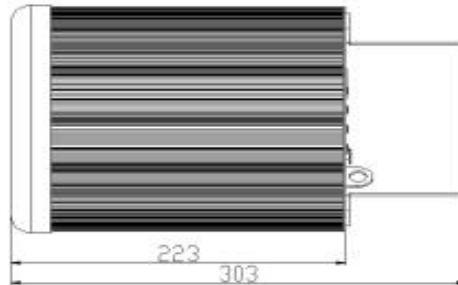
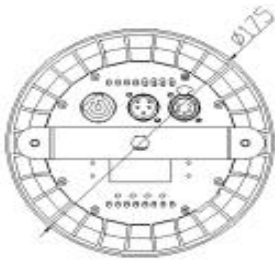

3.Parts

Standard accessories

1. 1PCS 1.5m POWERCON
2. 1PCS 1.5m three core DMX signal wire

Optional accessories:

1. Handle
- 2.Lamp hook (various models available)

4.Lighting setting parameter reset

4.1.Hoisting

The lamp hook or safety rope can be used according to the situation.
Lamp hook (only one lamp can be hoisted)

We provide different types of lamp hooks for selection. The following installation drawing is for reference.

Use screws and nuts to fix the lamp hook on the lamp through the hole above the lamp. Fix the lamp on the bracket.

MOUNTING HOLE FOR LAMP HOOK

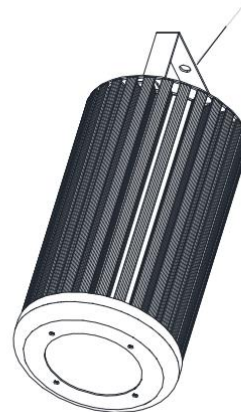

4.2. DMX512 Connection

DMX signal line (30 lamps in series)

Power supply (one power supply is connected to only one lamp)

The following installation drawing is for reference:

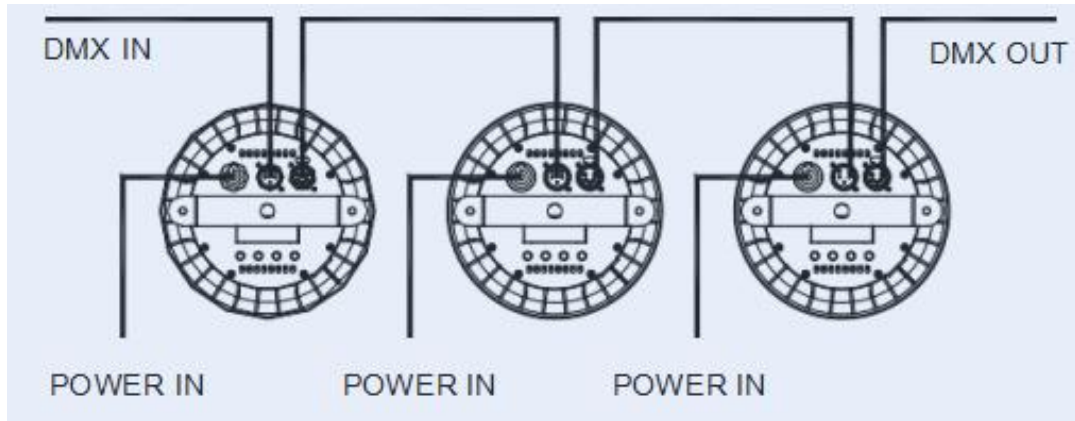

5. How to set the unit

5.1. Control panel

1. ① **DISPLAT**: Display various function menus

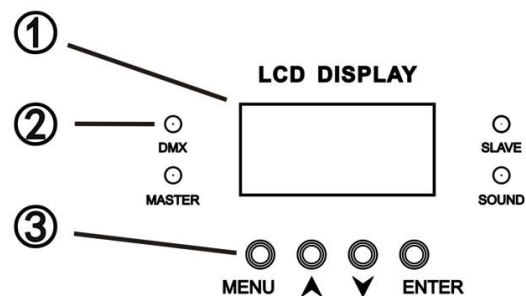

2. ② **LED**:

DMX	on	DMX signal connected
MASTER	on	Master mode
SLAVE	on	Slave mode
SOUND	flash	Sound active

3. ③ **Button**:

MENU	Go to menu selection
▲ DOWN	Go to the next option
▼ UP	Go back to the previous option
ENTER	Confirm the selected function

4. **Power input**: connect the power supply;

5. **3-core DMX input**: use 3-core XLR signal wire to connect the lamp and DMX console, and input DMX signal;

6. **3-core DMX output**: connect the next lamp with 3-core XLR signal wire and output DMX signal;

5.2. Main Function

Turn on the light, press the **MENU** button to enter the menu mode, use the **UP** and **DOWN** buttons to find the menu, when the preset menu is displayed on the display screen, press the **ENTER** button to confirm, use the **UP** and **DOWN** buttons to select the sub menu, press the **ENTER** button to save the settings or automatically return to the previous menu. Press the **MENU** button to return, or wait for one minute and then exit the menu mode automatically. When there is no power connection, press **UP** button

for 1 minute to enter the menu mode. After setting, press **MENU** button or wait for 1 minute to exit the power-off setting function automatically.

Note: in the host mode, press and hold the Enter key, and use up and down to adjust the dimming in the performance mode.

Main menu:

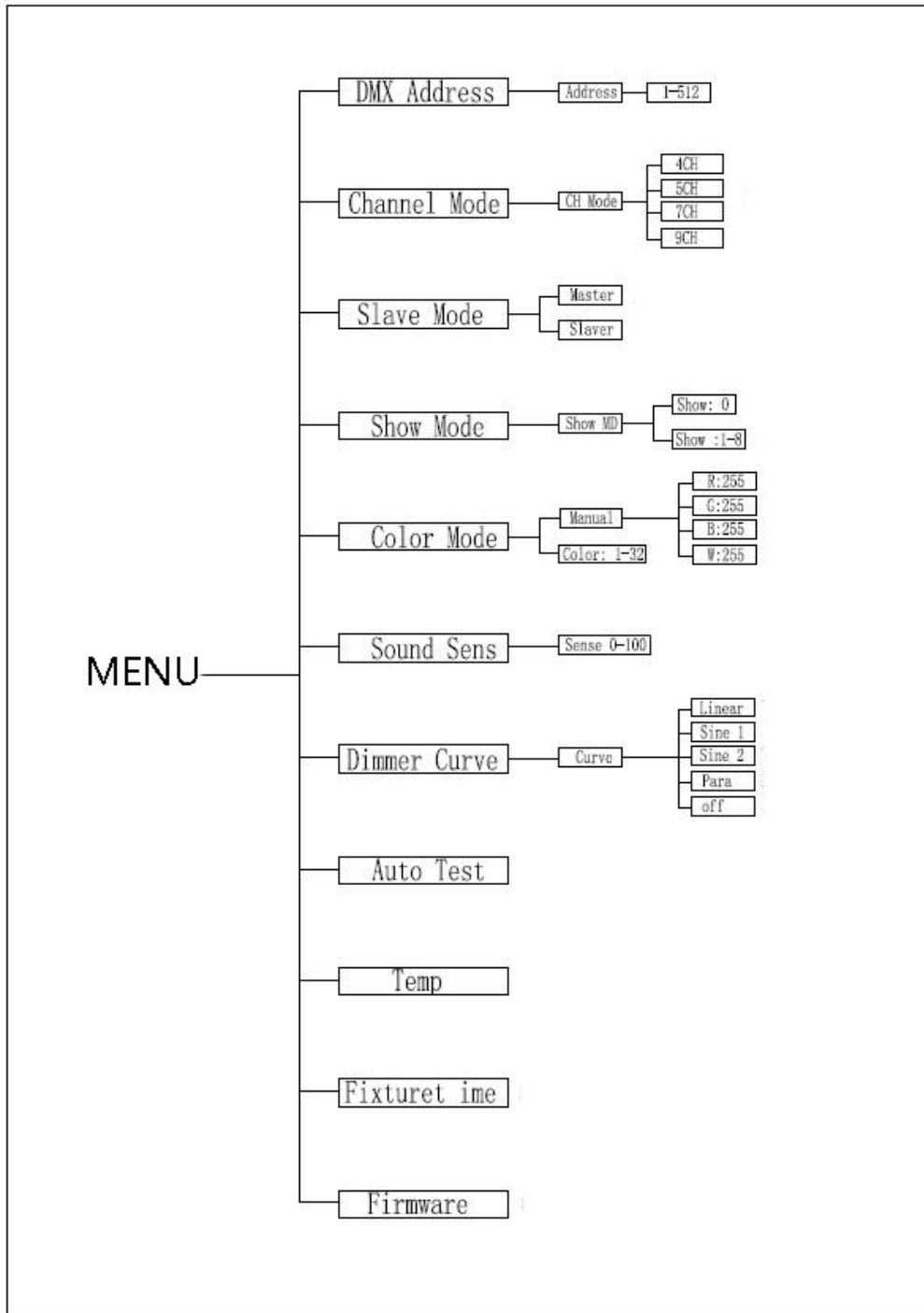

DMX Address

Select the **DMX address**, press **ENTER** to confirm, and the current **DMX address** will be displayed on the display. Use **UP / DOWN** button to select **001-512** address, and press **ENTER** button to save. Press

the **MENU** button to return to the previous menu or wait one minute for the menu mode to exit automatically.

Channel Mode

Select the **Channel Mode**, press **ENTER** to confirm, and the current **Channel Mode** will be displayed on the display. Use **UP / DOWN** button to select **4CH/5CH/7CH/9CH**, and press **ENTER** button to save. Press the **MENU** button to return to the previous menu or wait one minute for the menu mode to exit automatically.

Slave Mode

Select the **Slave Mode**, press **ENTER** to confirm, and the current **Slave Mode** will be displayed on the display. Use **UP / DOWN** button to select **Master/Slaver**, and press **ENTER** button to save. Press the **MENU** button to return to the previous menu or wait one minute for the menu mode to exit automatically.

Show Mode

Select the **Show Mode**, press **ENTER** to confirm, and the current **Show Mode** will be displayed on the display. Use **UP / DOWN** button to select **Show 0 (Voice control mode) /Show 1~8 (Performance mode1~8)**, and press **ENTER** button to save. Press the **MENU** button to return to the previous menu or wait one minute for the menu mode to exit automatically.

Color Mode

Select the **Color Mode**, press **ENTER** to confirm, and the current **Color Mode** will be displayed on the display. Use **UP / DOWN** button to select **Manual (Manual mode R:000 G:000 B:000 W:000) / Color 1...Color32**, and press **ENTER** button to save. Press the **MENU** button to return to the previous menu or wait one minute for the menu mode to exit .

Sound Sense

Select the **Sound Sense**, press **ENTER** to confirm, and the current **Sound Sense** will be displayed on the display. Use **UP / DOWN** button to select **0-100**, and press **ENTER** button to save. Press the **MENU** button to return to the previous menu or wait one minute for the menu mode to exit .

Dimmer Curve

Select the **Curve**, press **ENTER** to confirm, and the current **Curve** will be displayed on the display. Use **UP / DOWN** button to select **Linear** or **Sine1** or **Sine2** or **Para** or **off**, and press **ENTER** button to save. Press the **MENU** button to return to the previous menu or wait one minute for the menu mode to exit .

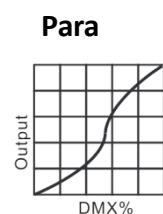
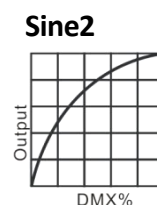
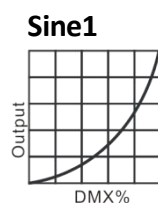
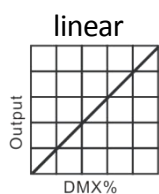

Auto Test

Select the **Auto Test**, press **ENTER** to confirm, The light will be automatically detected. Press the **MENU** button to return to menu mode.

Temp

Select the **Temp**, press **ENTER** to confirm, Display temperature. Press the **MENU** button to return to menu mode.

6. Lighting control

You can operate the unit in three ways:

- 1, By master/slave built-in auto-program function
- 2, By DMX controller

6.1. Master/Slave Built In auto -program Function

By linking the units in master/slave connection, the first unit will control the other units to give an automatic, sound activated, synchronized light show.

6.2. DMX Protocol Controller

Using universal DMX controller to control the units, you have to set DMX address from 1 to 512 channel so that the units can receive DMX signal.

Press the **MENU** button up to when the DMX Address is showing on the display. Pressing **ENTER** button and the display will blink. Use **DOWN** and **UP** button to change the DMX512 address.

Channel Mode	Unit 1 Addr	Unit 2 Addr	Unit 3 Addr	Unit 4 Addr
4 CH	1	5	9	13
5 CH	1	6	11	16
7 CH	1	8	15	22
9 CH	1	10	19	28

6.3. DMX512 configuration

4 Channel Mode:

Channel	Function	Value	
1CH	Red	000-255	
2CH	Green	000-255	
3CH	Blue	000-255	
4CH	White	000-255	

5 Channel Mode:

Channel	Function	Value	
1CH	Dimmer	000-255	
2CH	Red	000-255	
3CH	Green	000-255	
4CH	Blue	000-255	
5CH	White	000-255	

7 Channel Mode:

Channel	Function	Value	
1CH	Dimmer	000-255	
2CH	Red	000-255	
3CH	Green	000-255	
4CH	Blue	000-255	
5CH	White	000-255	
6CH	Strobe	000-090	Slow to fast
		091-173	Dark to bright
		174-255	Bright to dark
7CH	Use menu setting Dimmer Mode	000-010	
	Dimmer off	011-020	
	Dimmer1	021-030	
	Dimmer2	031-040	
	Dimmer3	041-050	
	Dimmer4	051-060	
	Use menu setting Dimmer Mode	061-254	
Reset	255		

9 Channel Mode:

Channel	Function	Value	
---------	----------	-------	--

1CH	Dimmer	000-255	
2CH	Red	000-255	
3CH	Green	000-255	
4CH	Blue	000-255	
5CH	White	000-255	
6CH	Strobe	000-255	
7CH	Show_Standby	000-110	
	Show1-Show5	111-160	
	Fade1-Fade5	161-210	
	Show_Standby	211-255	
8CH	Speed	000-255	
9CH	CCT(3200K-6500K)	000-127	
	Colour(9 colour)	128-255	

7. DMX512 Connection

Mode connection:

1. Connect the fixture together in a “daisy chain” by XLR plug cable from the output of the fixture to the input of the next fixture. The cable cannot be branched or split to a “Y” cable. Inadequate or damaged cables, soldered joints or corroded connectors can easily distort the signal and shut down the system
2. The DMX output and input connectors are pass-through to maintain the DMX circuit when one of the units’ power is disconnected.
3. At last fixture, the DMX cable has to be terminated with a terminator to reduce signal errors. Solder a 120-ohm 1/4W resistor between pin 2 (DMX) and pin 3(DMX+) into a 5-pin XLR plug and plug it in the DMX output of the last fixture.
4. Each lighting fixture needs to have an address set to receive the data sent by the controller. The address number is between 0-511 (usually 0 & 1 are equal to 1).
5. 5 pin XLR connectors:
 - 5 pin XLR: Pin 1: GND, Pin 2: Negative signal (-), Pin 3: Positive signal (+) 4:Blank 5:Blank

8. Troubleshooting

Following are a few common problems that may occur during operation. Here are some suggestions for easy troubleshooting:

A. The fixture does not work, no light

1. Check the connection of power and main fuse.
2. Measure the mains voltage on the main connector.

B. Not responding to DMX controller

1. DMX LED should be on. If not, check DMX connectors, cables to see if link properly.
2. If the DMX LED is on and no response to the channel, check the address settings and DMX polarity.
3. If you have intermittent DMX signal problems, check the pins on connectors or on PCB of the fixture or the previous one.
4. Try to use another DMX controller.
5. Check if the DMX cables run near or run alongside to high voltage cables that may cause damage or interference to DMX interface circuit.

9. Fixture Cleaning

The cleaning of internal must be carried out periodically to optimize light output. Cleaning frequency depends on the environment in which the fixture operates: damp, smoky or particularly dirty surrounding can cause greater accumulation of dirt on the fixture's optics.

- Clean with soft cloth using normal glass cleaning fluid.
- Always dry the parts carefully.
- Clean the external optics at least every 20 days. Clean the internal optics at least every 30/60 days.

